



## TECHNICAL DATA

## SOLID CONE SPRAY NOZZLES

The Viking Corporation, 210 N Industrial Park Drive, Hastings MI 49058

Telephone: 269-945-9501 Technical Services: 877-384-5464 Fax: 269-818-1680 Email: techsvcs@vikingcorp.com

Visit the Viking website for the latest edition of this technical data page.

### 1. DESCRIPTION

Viking Model A-2, A-2X, B-2, C-2, and D-2 Solid Cone Spray Nozzles are “non-automatic” pattern, open, directional discharge spray nozzles. The spray nozzle units feature two-piece construction consisting of a cast bronze body and threaded insert. The insert determines the included angle of discharge and the body construction provides a uniform distribution throughout the discharge pattern. When spraying, the nozzle discharge forms a solid, cone-shaped spray pattern meeting the requirements for medium- and high-velocity water spray systems.

Optional dust plugs are available to prevent foreign material from entering the open end of the spray nozzle. They are designed to blow off when the system piping is pressurized.

### 2. LISTINGS AND APPROVALS



**cULus Listed: Category VGYZ**



**FM Approved: Water-Spray Systems**

**NYC Approved:** Calendar Number 219-76-SA, Bulletin No. 16, Vol. LXI



**CCCF Approved:** Approved by the China Certification Center for Fire Products (CCCF)

The nozzles are approved for use in medium- and high-velocity water spray systems. Refer to the Approval Charts on pages 4-5 and Design Criteria on page 6 for cULus and FM approval requirements that must be followed.

NOTE: Other international approval certificates may be available upon request.

### 3. TECHNICAL DATA

#### Specifications:

Available since 1971.

The water inlet is at a 90° angle to the nozzle outlet. The smallest nozzle passage is 1/4"

(6 mm) for Part Nos. 05133AAJ through 05134AJN; 11/32 (9 mm) for Part Nos. 05135AAJ through 05135AJN; 3/8" (10 mm) for Part Nos. 19505J through 19505JN; and 7/16" (11 mm) for Part Nos. 19506AJ through 19506JN.

All bodies are permanently marked with the model number.

All inserts are permanently marked with the angle of discharge and model.

Inserts are available in spray angles of 30°, 60°, 90°, 120°, and 140°

Refer to pages 7-13 for spray nozzle water distribution patterns.

Thread size: 1/2" (15 mm) NPT male thread is standard

Nominal K-Factors: Refer to the Approval Charts

#### Dust Plugs (Optional):

Polyethylene Cap: 1" (25 mm) deep

Rated for a continuous temperature of 220 °F (104 °C).

#### Spray Nozzle Material Standards:

Body Casting: Brass UNS-C84400

Insert: Brass UNS-C36000

**Ordering Information:** (Also refer to the current Viking price list.)

Order Model A-2, A-2X, B-2, C-2, and D-2 Solid Cone Spray Nozzles by selecting the appropriate part number from the Approval Charts.

**Available Finishes:** Brass or Electroless Nickel. Refer to the Approval Charts

For example, Spray Nozzle Model A-2 (VK740) with a 1.2 K-Factor, a 30° spray angle, and a Brass finish = Part No. 05133AAJ

**Dust Plugs (Optional):** Dust plugs are used to prevent the depositing of foreign materials in the waterway, which could interfere with the discharge of the spray nozzles. The plugs are designed to blow off when the system piping is pressurized.

Part Number 02409A for use with Spray Nozzle Part Nos. 05133AAJ through 05135AJN.

Part Number 02410A for use with Spray Nozzle Part Nos. 19505AJ through 19506JN.



**Solid Cone Spray Nozzles**

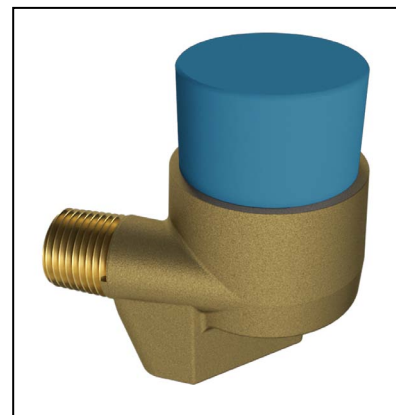

**Spray Nozzle Dust Plug**



## TECHNICAL DATA

## SOLID CONE SPRAY NOZZLES

The Viking Corporation, 210 N Industrial Park Drive, Hastings MI 49058  
 Telephone: 269-945-9501 Technical Services: 877-384-5464 Fax: 269-818-1680 Email: techsvcs@vikingcorp.com  
 Visit the Viking website for the latest edition of this technical data page.

### 4. INSTALLATION

#### ⚠ WARNING

Viking Model A-2, A-2X, B-2, C-2, and D-2 Solid Cone Spray Nozzles are manufactured and tested to meet the rigid requirements of the approving agency. The nozzles are designed to be installed in accordance with recognized installation standards. Deviation from the standards or any alteration to the nozzle after it leaves the factory including, but not limited to: painting, plating, coating, or modification, may render the unit inoperative and will automatically nullify the approval and any guarantee made by The Viking Corporation.

The Approval Charts on pages 4-5 show listings and approvals of Model A-2, A-2X, B-2, C-2, and D-2 Spray Nozzles for use on water spray systems. The charts show listings and approvals available at the time of printing. Other approvals are in process. Check with the manufacturer for any additional approvals.

- A. **Spray nozzles are to be installed in accordance with the latest edition of Viking technical data, the latest published standards of NFPA, FM Global, LPCB, APSAD, VdS or other similar organizations, and also with the provisions of governmental codes, ordinances, and standards whenever applicable. The use of Model A-2, A-2X, B-2, C-2, and D-2 Spray Nozzles may be limited due to occupancy and hazard. Refer to the Authority Having Jurisdiction prior to installation.**
- B. Spray nozzles are installed on fixed fire protection systems, such as deluge systems, where total flooding is required.
- C. Handle Spray Nozzles with care. They must be stored in a cool, dry place in their original shipping container. Never install a spray nozzle that has been dropped or damaged.
- D. Corrosion-resistant spray nozzles must be installed when subject to corrosive atmospheres. When installing corrosion resistant nozzles, take care not to damage the corrosion resistant coating.
- E. Spray nozzles must be installed after the piping is in place to prevent mechanical damage.
- F. Before installing, be sure to have the appropriate model, with the correct K-Factor and spray angle. Spray nozzle bodies are permanently marked with the model number. All inserts are permanently marked with the angle of discharge and model.
  - 1. Apply a small amount of pipe-joint compound or tape to the external threads of the spray nozzle only, taking care not to allow a build-up of compound inside the inlet.
  - 2. Install the nozzle on the fixed piping using a standard crescent wrench. Take care not to over-tighten or damage the spray nozzle.
- G. Spray nozzles must be protected from mechanical damage. Where open spray nozzles are used, care must be taken to prevent foreign materials from entering the orifice. Foreign materials may accumulate and restrict or plug the waterway and may prevent proper operation of the spray nozzle.
- H. Install dust plugs (if used): After installing the spray nozzle unit, press the dust cover over the end of the nozzle insert.

### 5. OPERATION

Model A-2, A-2X, B-2, C-2, and D-2 Solid Cone Spray Nozzles are designed to apply cooling water to exposed vertical, horizontal, curved, and irregular shaped surfaces to allow cooling of objects externally when exposed to an adjacent fire. Cooling is done to prevent objects from absorbing heat that could cause structural damage and possible spread of fire to the protected object. In some applications, Model A-2, A-2X, B-2, C-2, and D-2 Spray Nozzles may be applied to control or extinguish fire of the protected area (depending on water design application density).

### 6. INSPECTIONS, TESTS AND MAINTENANCE

#### NOTICE

The owner is responsible for maintaining the fire protection system and devices in proper operating condition. For minimum maintenance and inspection requirements, refer to the NFPA standard (e.g., NFPA 25) that describes care and maintenance of sprinkler systems. In addition, the Authority Having Jurisdiction may have additional maintenance, testing, and inspection requirements that must be followed.

- A. Spray nozzles must be inspected on a regular basis for corrosion, mechanical damage, obstructions, paint, etc. Where open spray nozzles are installed, verify that foreign materials (such as dust, dirt, etc.) do not restrict or plug the waterspray. The frequency of inspections may vary due to corrosive atmospheres, water supplies, and activity around the device. It is also recommended that outdoor installations of Solid Cone Spray Nozzles with dust plugs be periodically inspected, during freezing weather conditions, for the presence of ice buildup from trapped condensate which could effect the proper release of the plugs.



## TECHNICAL DATA

## SOLID CONE SPRAY NOZZLES

The Viking Corporation, 210 N Industrial Park Drive, Hastings MI 49058

Telephone: 269-945-9501 Technical Services: 877-384-5464 Fax: 269-818-1680 Email: techsvcs@vikingcorp.com

Visit the Viking website for the latest edition of this technical data page.

B. Spray nozzles that have been painted or mechanically damaged must be replaced immediately. Nozzles showing signs of corrosion shall be tested and/or replaced immediately as required. When replacing spray nozzles, use only new spray nozzles.

1. Using a standard crescent wrench, remove the old spray nozzle and install the new unit. Care must be taken to ensure that the replacement spray nozzle is the proper model with the correct K-Factor. Spray nozzle bodies are permanently marked with the model number. All inserts are permanently marked with the angle of discharge and model.

C. The spray nozzle discharge pattern is critical for proper fire protection. Therefore, nothing should be hung from, attached to, or otherwise obstruct the discharge pattern. All obstructions must be immediately removed or, if necessary, additional nozzles installed.

D. Fire protection systems that have been subjected to a fire must be returned to service as soon as possible. The entire system must be inspected for damage and repaired or replaced as necessary. Spray nozzles that have been exposed to corrosive products of combustion or high ambient temperatures, should be replaced. Refer to the Authority Having Jurisdiction for minimum replacement requirements.

### 7. AVAILABILITY

The Viking Model A-2, A-2X, B-2, C-2, and D-2 Solid Cone Spray Nozzles are available through a network of domestic and international distributors. See The Viking Corporation web site for the closest distributor or contact The Viking Corporation.

### 8. GUARANTEE

For details of warranty, refer to Viking's current list price schedule or contact Viking directly.

TABLE 1: SPRAY NOZZLE DIMENSIONS

SIN	A	B	C	D	E	F	G	H
VK740-VK764	1-7/8" (48 mm)	7/8" (22 mm)	1/2" (13 mm)	1-5/8" (41 mm)	13/16" (21 mm)	5/16" (8 mm)	1-17/64" (32 mm)	1-11/16" (43 mm)
VK770-VK784	2-1/16" (52 mm)	1" (25 mm)	5/8" (16 mm)	2-3/16" (56 mm)	1" (25 mm)	3/8" (10 mm)	1-17/32" (39 mm)	2" (51 mm)

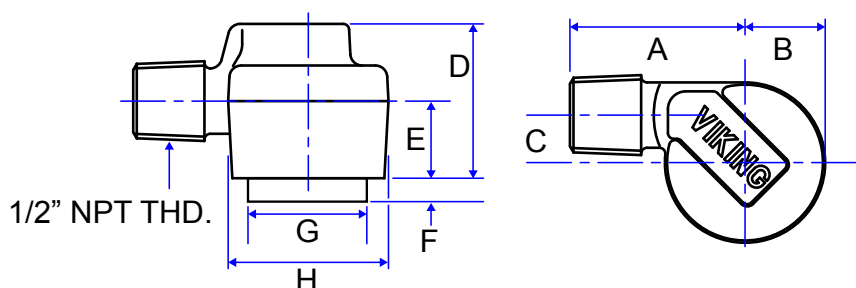

Figure 1: Spray Nozzle Dimensions



## TECHNICAL DATA

## SOLID CONE SPRAY NOZZLES

The Viking Corporation, 210 N Industrial Park Drive, Hastings MI 49058  
 Telephone: 269-945-9501 Technical Services: 877-384-5464 Fax: 269-818-1680 Email: techsvcs@vikingcorp.com  
 Visit the Viking website for the latest edition of this technical data page.

### Approval Chart 1

#### Model A-2, A-2X, B-2, C-2, and D-2 Spray Nozzles - Brass Finish

Part Number <sup>1</sup>	SIN	Nominal K-Factor		Angle	Listings and Approvals <sup>3</sup> (Refer also to Design Criteria on page 6.)						Part Number <sup>1</sup>	SIN	Nominal K-Factor		Angle	Listings and Approvals <sup>3</sup> (Refer also to Design Criteria on page 6.)					
		U.S.	metric <sup>2</sup>		cULus <sup>4</sup>	NYC <sup>5</sup>	FM	LPCB	CCC <sup>6</sup>	VdS			U.S.	metric <sup>2</sup>		cULus <sup>4</sup>	NYC <sup>5</sup>	FM	LPCB	CCC <sup>6</sup>	VdS
<b>Model A-2 Brass Finish</b>																					
05133AAJ	VK740	1.2	17.3	30°	Yes	Yes	Yes <sup>6</sup>	--	--	--	05133AAM	VK743	1.4	20.2	120°	Yes	Yes	Yes <sup>6</sup>	--	--	--
05133AAK	VK741	1.2	17.3	60°	Yes	Yes	Yes <sup>6</sup>	--	--	--	15581AM	VK743	1.5	21.6	120°	Yes	Yes	Yes <sup>6</sup>	--	Yes	Yes
05133AAL	VK742	1.2	17.3	90°	Yes	Yes	Yes <sup>6</sup>	--	--	--	19950AM	VK743	1.4	20.2	120°	Yes	--	Yes <sup>6</sup>	--	Yes	--
15581AL	VK742	1.2	17.3	90°	Yes	Yes	Yes <sup>6</sup>	--	Yes	Yes	21416AM	VK743	1.4	20.2	120°	Yes	--	Yes <sup>6</sup>	--	Yes	--
19950AL	VK742	1.2	17.3	90°	Yes	--	Yes <sup>6</sup>	--	Yes	--	05133AAN	VK744	1.4	20.2	140°	Yes	Yes	Yes <sup>6</sup>	--	--	--
21416AL	VK742	1.2	17.3	90°	Yes	--	Yes <sup>6</sup>	--	Yes	--	--	--	--	--	--	--	--	--	--	--	--
<b>Model A-2X Brass Finish</b>																					
05134AAJ	VK750	2.0	28.8	30°	Yes	Yes	Yes <sup>6</sup>	--	--	--	05134AAM	VK753	2.2	31.7	120°	Yes	Yes	Yes <sup>6</sup>	--	--	--
05134AAK	VK751	2.0	28.8	60°	Yes	Yes	Yes <sup>6</sup>	--	--	--	19951AM	VK753	2.2	31.7	120°	Yes	--	Yes <sup>6</sup>	--	Yes	--
05134AAL	VK752	2.0	28.8	90°	Yes	Yes	Yes <sup>6</sup>	--	--	--	21417AM	VK753	2.2	31.7	120°	Yes	--	Yes <sup>6</sup>	--	Yes	--
19951AL	VK752	2.0	28.8	90°	Yes	--	Yes <sup>6</sup>	--	Yes	--	05134AAN	VK754	2.2	31.7	140°	Yes	Yes	Yes <sup>6</sup>	--	--	--
21417AL	VK752	2.0	28.8	90°	Yes	--	Yes <sup>6</sup>	--	Yes	--	--	--	--	--	--	--	--	--	--	--	--
<b>Model B-2 Brass Finish</b>																					
05135AAJ	VK760	2.8	40.3	30°	Yes	Yes	Yes	--	--	--	05135AAM	VK763	3.3	47.5	120°	Yes	Yes	Yes	--	--	--
05135AAK	VK761	2.8	40.3	60°	Yes	Yes	Yes	--	--	--	19952AM	VK763	3.3	47.5	120°	Yes	--	Yes	--	Yes	--
05135AAL	VK762	2.8	40.3	90°	Yes	Yes	Yes	--	--	--	21418AM	VK763	3.3	47.5	120°	Yes	--	Yes	--	Yes	--
19952AL	VK762	2.8	40.3	90°	Yes	--	Yes	--	Yes	--	05135AAN	VK764	3.3	47.5	140°	Yes	Yes	Yes	--	--	--
21418AL	VK762	2.8	40.3	90°	Yes	--	Yes	--	Yes	--	--	--	--	--	--	--	--	--	--	--	--
<b>Model C-2 Brass Finish</b>																					
19505AJ	VK770	3.3	47.5	30°	Yes	--	--	--	--	--	19953AL	VK772	3.8	54.7	90°	Yes	--	Yes	--	Yes	--
19505AK	VK771	3.3	47.5	60°	Yes	--	--	--	--	--	19505AM	VK773	3.7	53.3	120°	Yes	--	Yes	--	--	--
19505AL	VK772	3.8	54.7	90°	Yes	--	Yes	--	--	--	19505AN	VK774	3.7	53.3	140°	Yes	--	Yes <sup>7</sup>	--	--	--
<b>Model D-2 Brass Finish</b>																					
19506AJ	VK780	4.3	61.9	30°	Yes	--	--	--	--	--	19954AL	VK782	5.0	72.0	90°	Yes	--	Yes <sup>7</sup>	--	Yes	--
19506AK	VK781	4.8	69.1	60°	Yes	--	Yes <sup>7</sup>	--	--	--	19506AM	VK783	4.9	70.6	120°	Yes	--	Yes <sup>7</sup>	--	--	--
19506AL	VK782	5.0	72.0	90°	Yes	--	Yes <sup>7</sup>	--	--	--	19506AN	VK784	4.9	70.6	140°	Yes	--	Yes <sup>7</sup>	--	--	--

#### Footnotes

<sup>1</sup> Spray nozzle bodies are permanently marked with the model number. All inserts are permanently marked with the angle of discharge and model.

<sup>2</sup> Metric K-Factor shown is when pressure is measured in Bar. When pressure is measured in kPa, divide the metric K-Factor shown by 10.0.

<sup>3</sup> This table shows the listings and approvals available at the time of printing. Check with the manufacturer for any additional approvals.

<sup>4</sup> Listed by Underwriters Laboratories Inc. for use in the U.S. and Canada.

<sup>5</sup> Approved by the NYC Board of Standards and Appeals, MEA No. 219-76-SA, Bulletin No. 16, Vol. LXI.

<sup>6</sup> Orifice diameter is less than 3/8" (9.4mm) for Model A-2 Nozzles with K-Factors of 1.2 and 1.4 and Model A-2X Nozzles with K-Factors of 2.0 and 2.2. A pipeline strainer with a 1/8" (3.2mm) or less perforation is required for FM Approval.

<sup>7</sup> Tolerance within 8% of k-factor.



## TECHNICAL DATA

## SOLID CONE SPRAY NOZZLES

The Viking Corporation, 210 N Industrial Park Drive, Hastings MI 49058  
 Telephone: 269-945-9501 Technical Services: 877-384-5464 Fax: 269-818-1680 Email: techsvcs@vikingcorp.com  
 Visit the Viking website for the latest edition of this technical data page.

### Approval Chart 2

#### Model A-2, A-2X, B-2, C-2, and D-2 Spray Nozzles - Electroless Nickel Finish

Part Number <sup>1</sup>	SIN	Nominal K-Factor		Angle	Listings and Approvals <sup>3</sup> (Refer also to Design Criteria on page 6.)				Part Number <sup>1</sup>	SIN	Nominal K-Factor		Angle	Listings and Approvals <sup>3</sup> (Refer also to Design Criteria on page 6.)			
		U.S.	metric <sup>2</sup>		cULus <sup>4</sup>	NYC <sup>5</sup>	FM	LPCB			U.S.	metric <sup>2</sup>		cULus <sup>4</sup>	NYC <sup>5</sup>	FM	LPCB
<b>Model A-2 Electroless Nickel Finish</b>																	
05133AJJ	VK740	1.2	17.3	30°	Yes	Yes	Yes <sup>6</sup>	--	05133AJM	VK743	1.4	20.2	120°	Yes	Yes	Yes <sup>6</sup>	--
05133AJK	VK741	1.2	17.3	60°	Yes	Yes	Yes <sup>6</sup>	--	05133AJN	VK744	1.4	20.2	140°	Yes	Yes	Yes <sup>6</sup>	--
05133AJL	VK742	1.2	17.3	90°	Yes	Yes	Yes <sup>6</sup>	--	--	--	--	--	--	--	--	--	--
05134AJJ	VK750	2.0	28.8	30°	Yes	Yes	Yes <sup>6</sup>	--	05134AJM	VK753	2.2	31.7	120°	Yes	Yes	Yes <sup>6</sup>	--
05134AJK	VK751	2.0	28.8	60°	Yes	Yes	Yes <sup>6</sup>	--	05134AJN	VK754	2.2	31.7	140°	Yes	Yes	Yes <sup>6</sup>	--
05134AJL	VK752	2.0	28.8	90°	Yes	Yes	Yes <sup>6</sup>	--	--	--	--	--	--	--	--	--	--
<b>Model B-2 Electroless Nickel Finish</b>																	
05135AJJ	VK760	2.8	40.3	30°	Yes	Yes	Yes	--	05135AJM	VK763	3.3	47.5	120°	Yes	Yes	Yes	--
05135AJK	VK761	2.8	40.3	60°	Yes	Yes	Yes	--	05135AJN	VK764	3.3	47.5	140°	Yes	Yes	Yes	--
05135AJL	VK762	2.8	40.3	90°	Yes	Yes	Yes	--	--	--	--	--	--	--	--	--	--
<b>Model C-2 Electroless Nickel Finish</b>																	
19505JJ	VK770	3.3	47.5	30°	Yes	--	--	--	19505JM	VK773	3.7	53.3	120°	Yes	--	Yes	--
19505JK	VK771	3.3	47.5	60°	Yes	--	--	--	19505JN	VK774	3.7	53.3	140°	Yes	--	Yes <sup>7</sup>	--
19505JL	VK772	3.8	54.7	90°	Yes	--	Yes	--	--	--	--	--	--	--	--	--	--
<b>Model D-2 Electroless Nickel Finish</b>																	
19506JJ	VK780	4.3	61.9	30°	Yes	--	--	--	19506JM	VK783	4.9	70.6	120°	Yes	--	Yes <sup>7</sup>	--
19506JK	VK781	4.8	69.1	60°	Yes	--	Yes <sup>7</sup>	--	19506JN	VK784	4.9	70.6	140°	Yes	--	Yes <sup>7</sup>	--
19506JL	VK782	5.0	72.0	90°	Yes	--	Yes	--	--	--	--	--	--	--	--	--	--

#### Footnotes

<sup>1</sup> Spray nozzle bodies are permanently marked with the model number. All inserts are permanently marked with the angle of discharge and model.

<sup>2</sup> Metric K-Factor shown is when pressure is measured in Bar. When pressure is measured in kPa, divide the metric K-Factor shown by 10.0.

<sup>3</sup> This table shows the listings and approvals available at the time of printing. Check with the manufacturer for any additional approvals.

<sup>4</sup> Listed by Underwriters Laboratories Inc. for use in the U.S. and Canada.

<sup>5</sup> Approved by the NYC Board of Standards and Appeals, MEA No. 219-76-SA, Bulletin No. 16, Vol. LXI.

<sup>6</sup> Orifice diameter is less than 3/8" (9.4mm) for Model A-2 Nozzles with K-Factors of 1.2 and 1.4 and Model A-2X Nozzles with K-Factors of 2.0 and 2.2. A pipeline strainer with a 1/8" (3.2mm) or less perforation is required for FM Approval.

<sup>7</sup> Tolerance within 8% of k-factor.



**TECHNICAL DATA**

**SOLID CONE  
SPRAY NOZZLES**

The Viking Corporation, 210 N Industrial Park Drive, Hastings MI 49058  
 Telephone: 269-945-9501 Technical Services: 877-384-5464 Fax: 269-818-1680 Email: techsvcs@vikingcorp.com  
 Visit the Viking website for the latest edition of this technical data page.

**DESIGN CRITERIA**

(Also refer to the Approval Charts on pages 4-5.)

**cULus Listing Requirements:**

Refer to the installation standards, such as NFPA 15, for minimum water supply requirements, nozzle pressure, and installation guidelines.

**FM Approval Requirements:**

For installation in accordance with the latest applicable FM Loss Prevention Data Sheets and Technical Advisory Bulletins. FM Global Loss Prevention Data Sheets and Technical Advisory Bulletins contain guidelines relating to, but not limited to: minimum water supply requirements, hydraulic design, ceiling slope and obstructions, minimum and maximum allowable spacing, and distance below the ceiling.

Pipeline Strainers Orifice diameter is less than 3/8" (9.4mm) for Model A-2 Nozzles with K-Factors of 1.2 and 1.4 and Model A-2X Nozzles with K-Factors of 2.0 and 2.2. A pipeline strainer with a 1/8" (3.2mm) or less perforation is required for FM Approval.

**NOTE: The FM installation guidelines may differ from cULus and/or NFPA criteria.**

**IMPORTANT: Always refer to Bulletin Form No. F\_091699 - Care and Handling of Sprinklers. Viking spray nozzles are to be installed in accordance with the latest edition of Viking technical data, the appropriate standards of NFPA, FM Global, LPCB, APSAD, VdS or other similar organizations, and also with the provisions of governmental codes, ordinances, and standards, whenever applicable.**

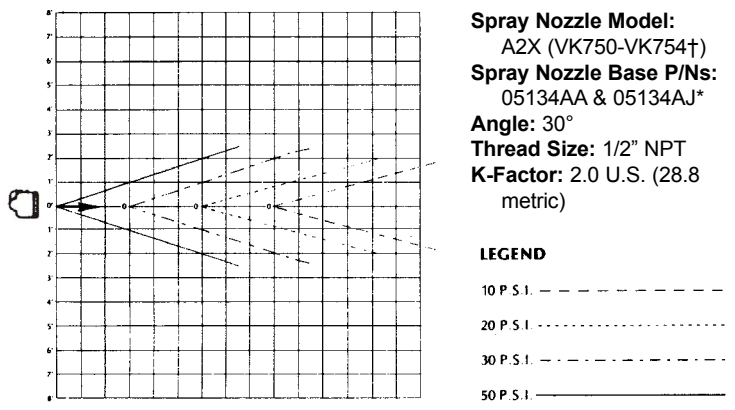

Top View-Horizontal Spray

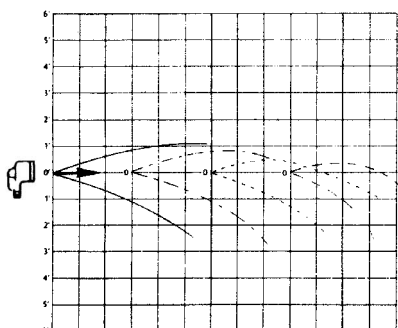

Side View-Horizontal Spray

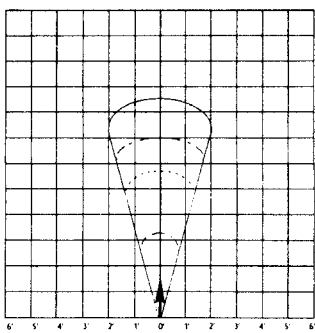

Side View Spray Up

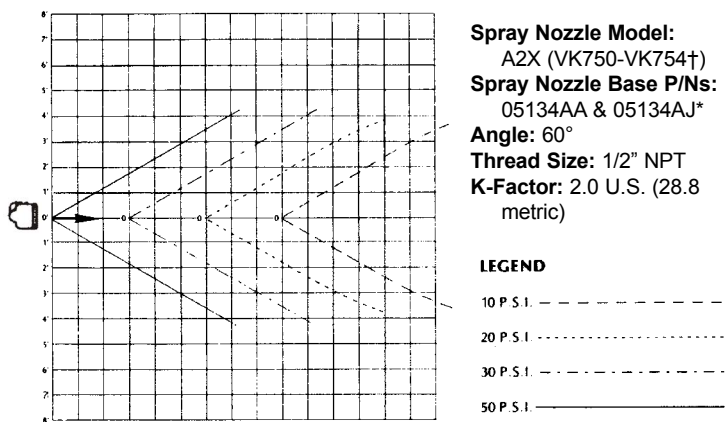

Top View-Horizontal Spray

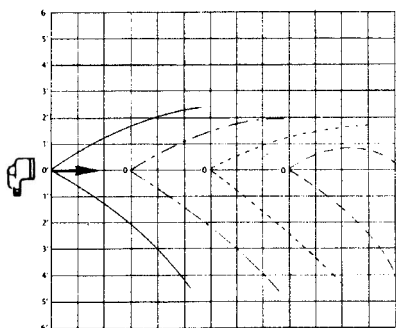

Side View-Horizontal Spray

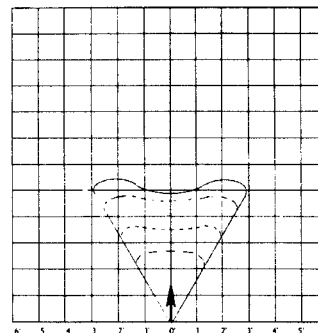

Side View Spray Up

Scale: Each square equals one square foot.

†Spray Nozzle Identification Numbers provided in accordance with the 1999 edition of NFPA 13, Section 3-2.2.

\* Base part numbers shown. For complete part number, refer to Viking's current price list.





**TECHNICAL DATA**

**SOLID CONE  
SPRAY NOZZLES**

The Viking Corporation, 210 N Industrial Park Drive, Hastings MI 49058  
 Telephone: 269-945-9501 Technical Services: 877-384-5464 Fax: 269-818-1680 Email: techsvcs@vikingcorp.com  
 Visit the Viking website for the latest edition of this technical data page.

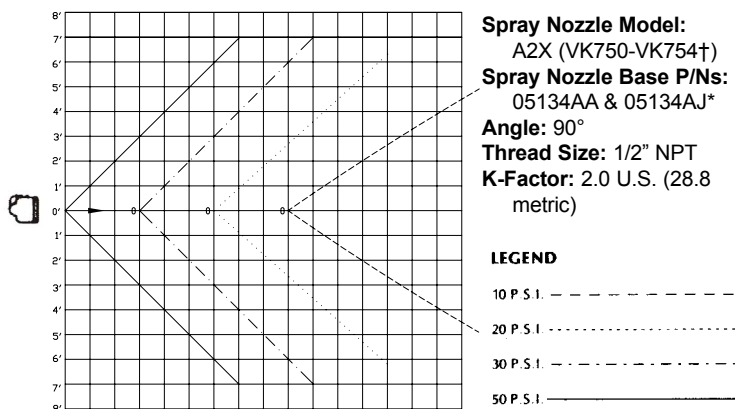

**Top View-Horizontal Spray**

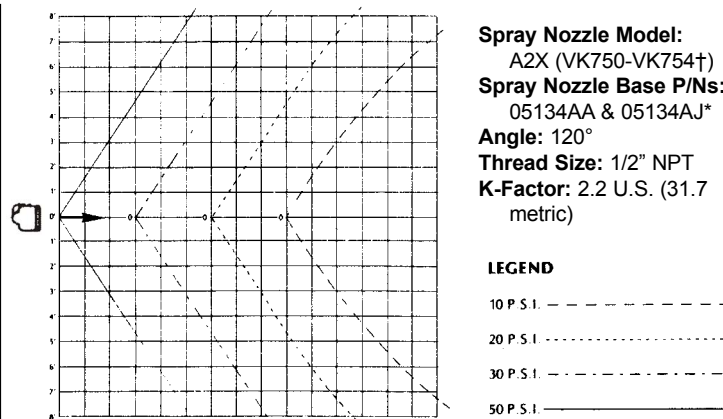
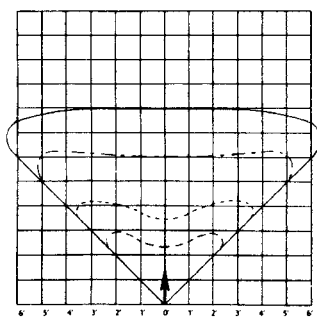
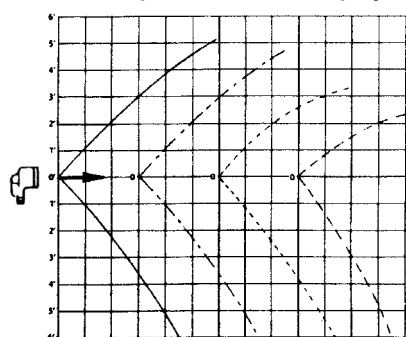

**Top View-Horizontal Spray**

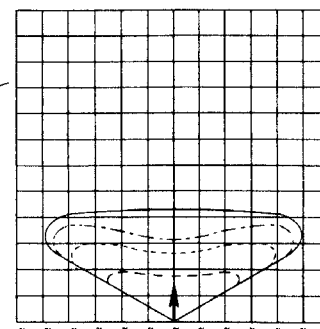
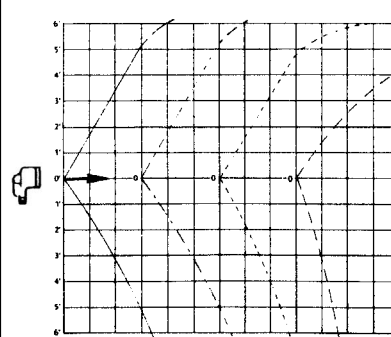

Scale: Each square equals one square foot.  
 †Spray Nozzle Identification Numbers provided in accordance with the 1999 edition of NFPA 13, Section 3-2.2.  
 \* Base part numbers shown. For complete part number, refer to Viking's current price list.



TECHNICAL DATA

SOLID CONE SPRAY NOZZLES

The Viking Corporation, 210 N Industrial Park Drive, Hastings MI 49058  
 Telephone: 269-945-9501 Technical Services: 877-384-5464 Fax: 269-818-1680 Email: techsvcs@vikingcorp.com  
 Visit the Viking website for the latest edition of this technical data page.

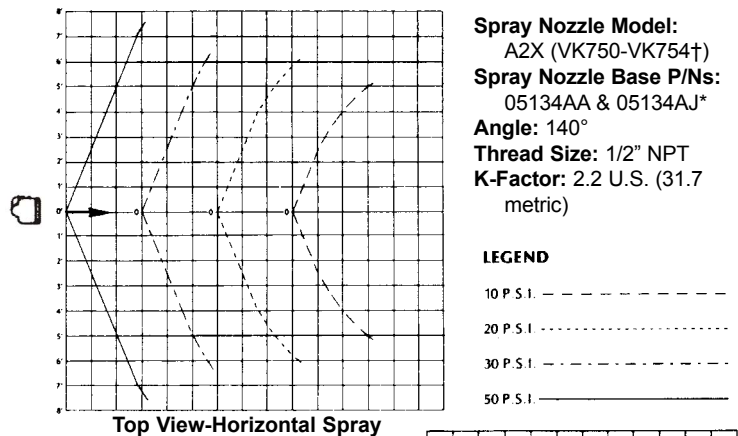

Top View-Horizontal Spray

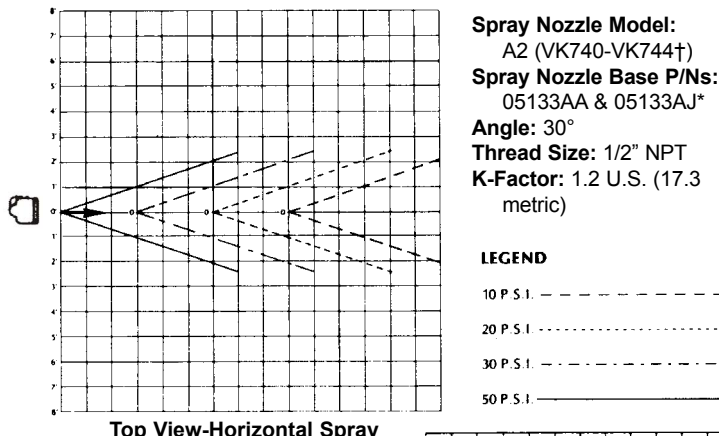
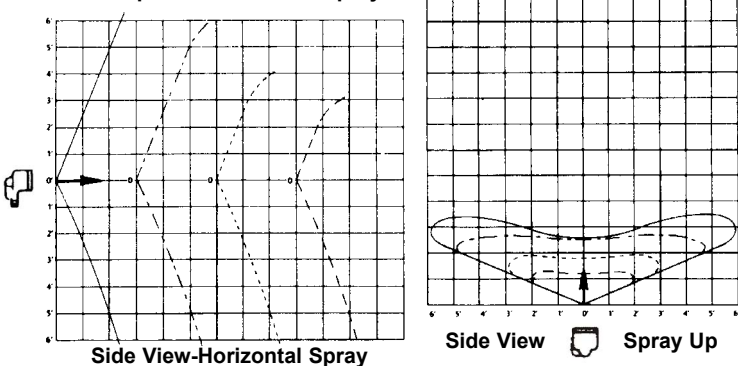

Top View-Horizontal Spray

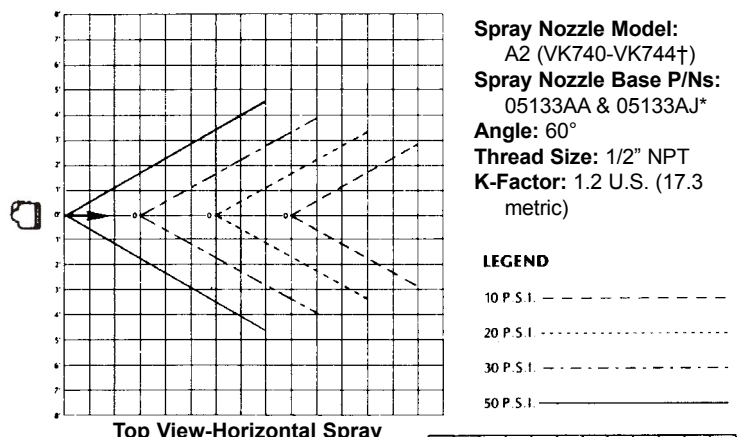
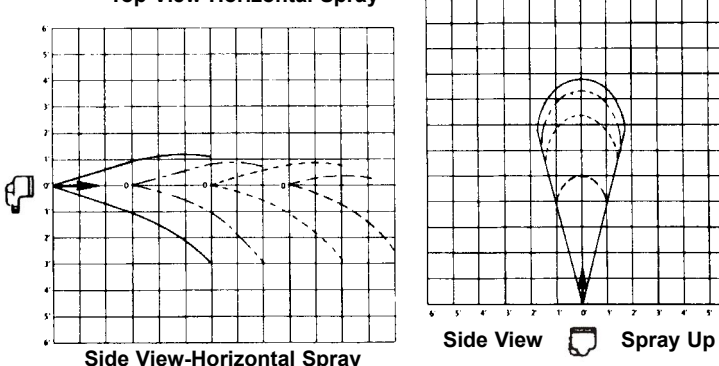

Top View-Horizontal Spray

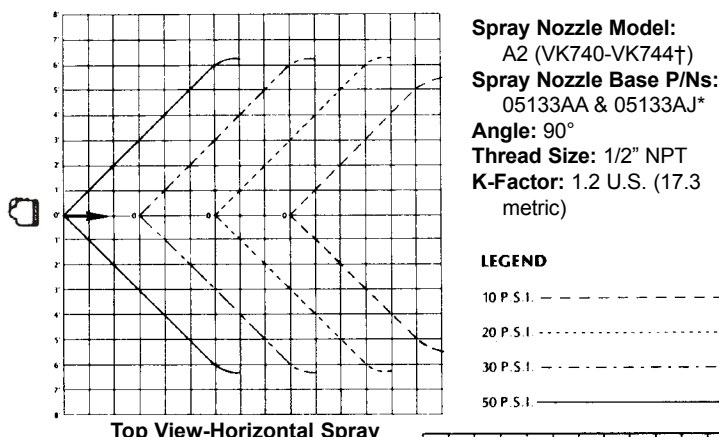
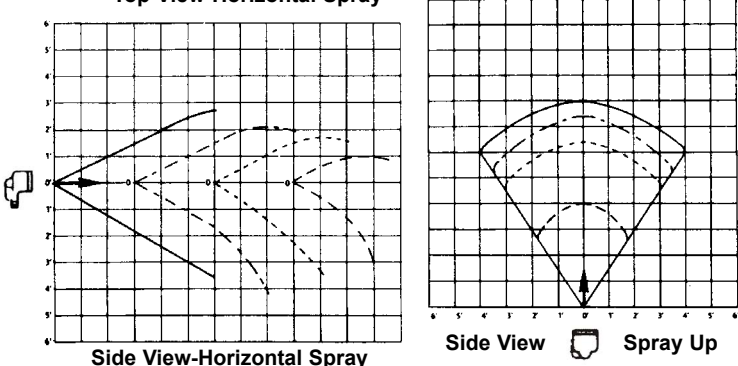

Top View-Horizontal Spray

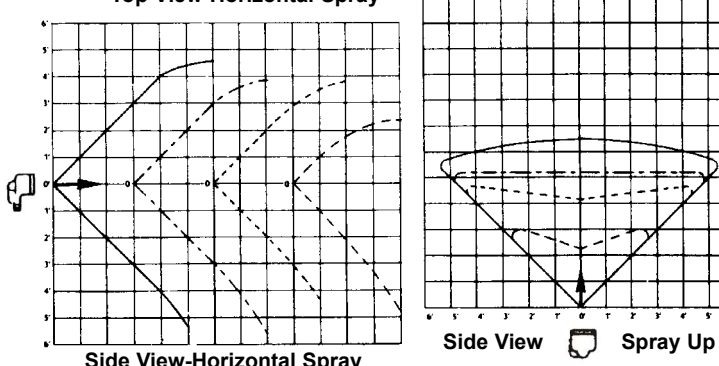





TECHNICAL DATA

SOLID CONE SPRAY NOZZLES

The Viking Corporation, 210 N Industrial Park Drive, Hastings MI 49058  
 Telephone: 269-945-9501 Technical Services: 877-384-5464 Fax: 269-818-1680 Email: techsvcs@vikingcorp.com  
 Visit the Viking website for the latest edition of this technical data page.

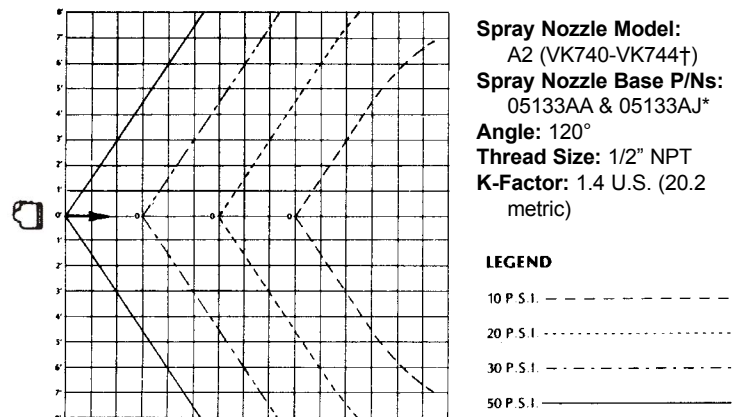

Top View-Horizontal Spray

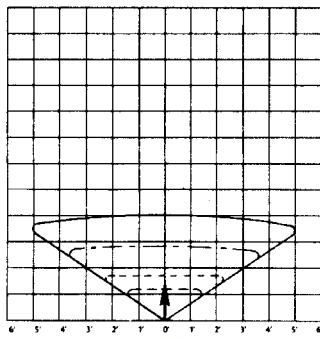
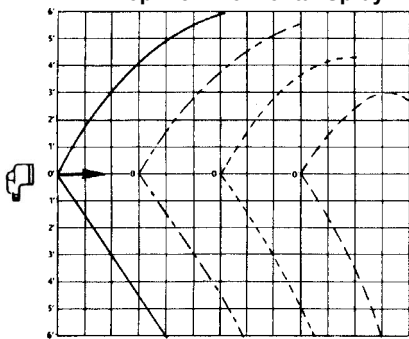

Side View-Horizontal Spray

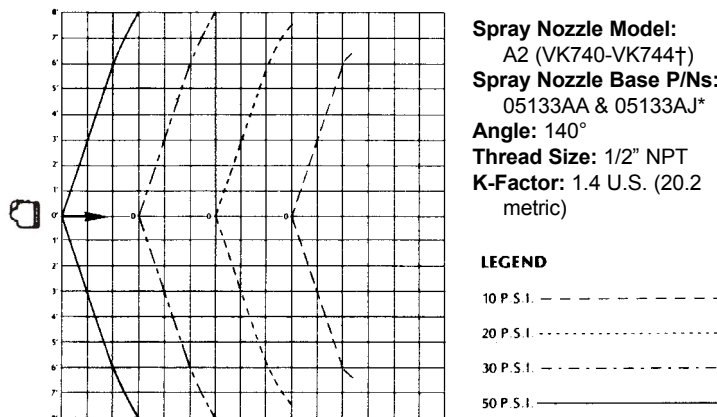

Top View-Horizontal Spray

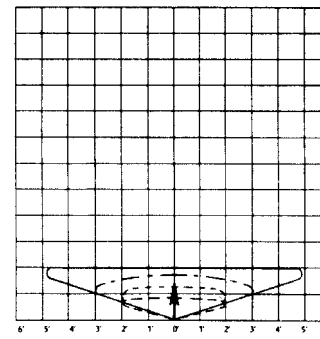
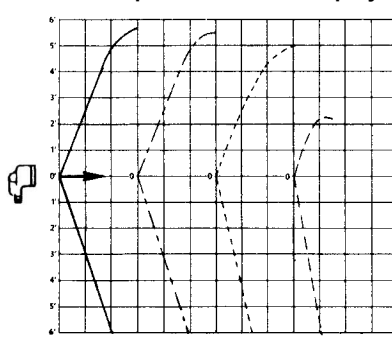

Side View-Horizontal Spray

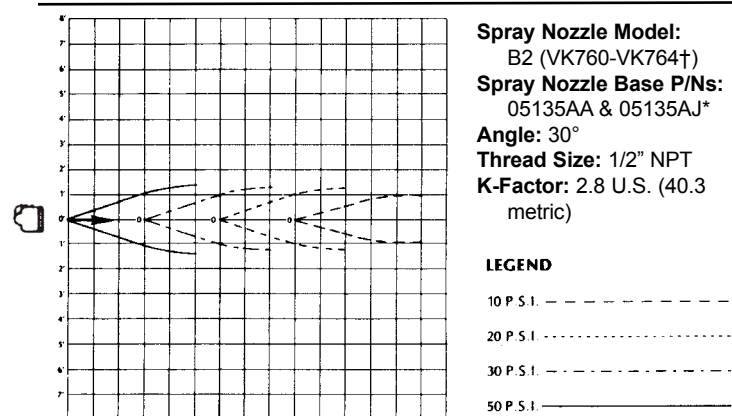

Top View-Horizontal Spray

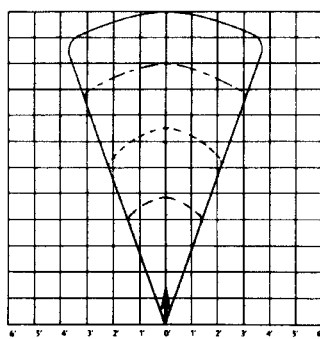
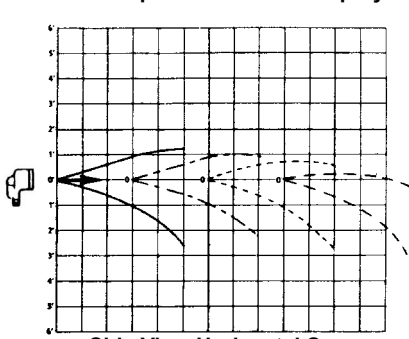

Side View-Horizontal Spray

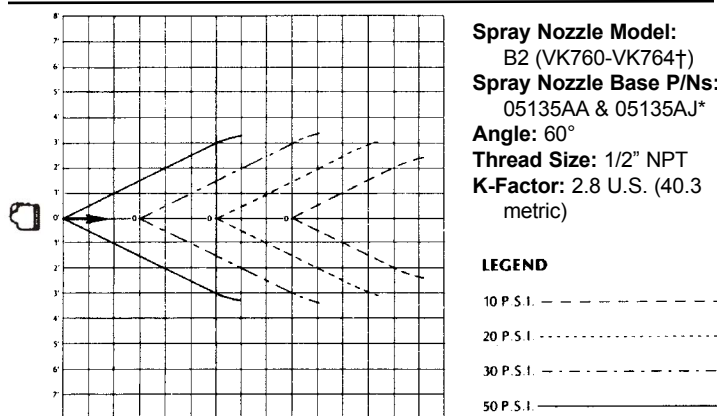

Top View-Horizontal Spray

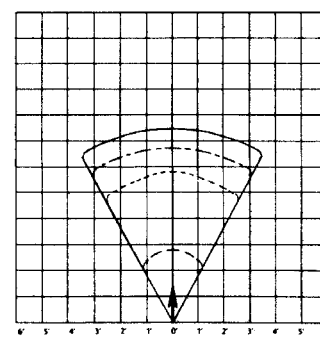
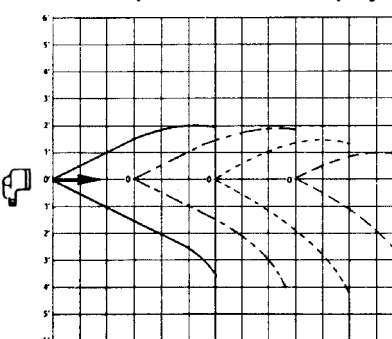

Side View-Horizontal Spray



TECHNICAL DATA

SOLID CONE SPRAY NOZZLES

The Viking Corporation, 210 N Industrial Park Drive, Hastings MI 49058  
 Telephone: 269-945-9501 Technical Services: 877-384-5464 Fax: 269-818-1680 Email: techsvcs@vikingcorp.com  
 Visit the Viking website for the latest edition of this technical data page.

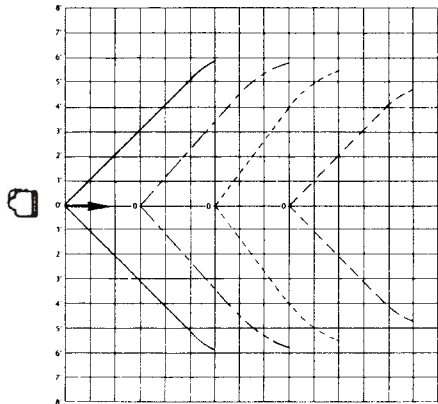

**Spray Nozzle Model:**  
 B2 (VK760-VK764†)  
**Spray Nozzle Base P/Ns:**  
 05135AA & 05135AJ\*  
**Angle:** 90°  
**Thread Size:** 1/2" NPT  
**K-Factor:** 2.8 U.S. (40.3 metric)

**LEGEND**  
 10 P.S.I. - - - - -  
 20 P.S.I. ······  
 30 P.S.I. - · - · -  
 50 P.S.I. \_\_\_\_\_

Top View-Horizontal Spray

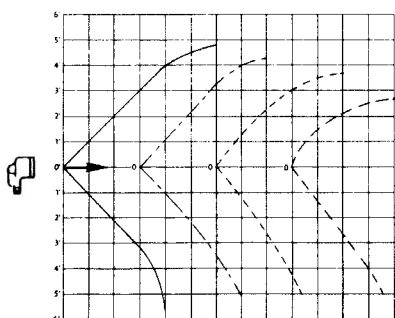

Side View-Horizontal Spray

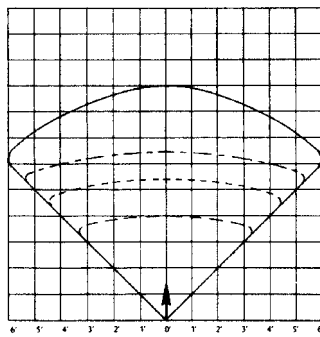

Side View Spray Up

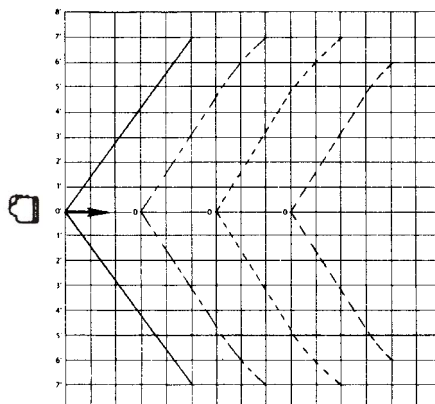

**Spray Nozzle Model:**  
 B2 (VK760-VK764†)  
**Spray Nozzle Base P/Ns:**  
 05135AA & 05135AJ\*  
**Angle:** 120°  
**Thread Size:** 1/2" NPT  
**K-Factor:** 3.3 U.S. (47.5 metric)

**LEGEND**  
 10 P.S.I. - - - - -  
 20 P.S.I. ······  
 30 P.S.I. - · - · -  
 50 P.S.I. \_\_\_\_\_

Top View-Horizontal Spray

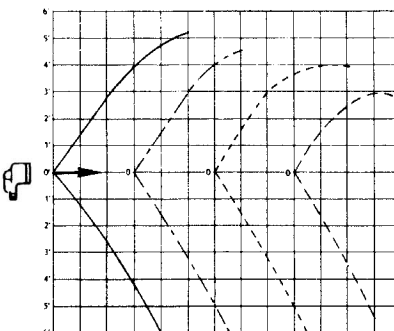

Side View-Horizontal Spray

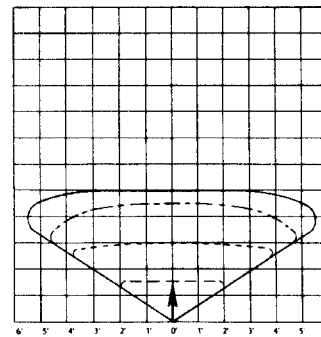

Side View Spray Up

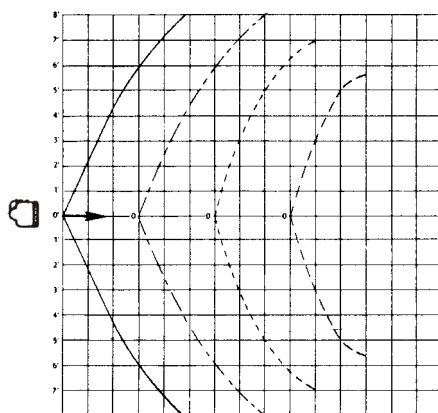

**Spray Nozzle Model:**  
 B2 (VK760-VK764†)  
**Spray Nozzle Base P/Ns:**  
 05135AA & 05135AJ\*  
**Angle:** 140°  
**Thread Size:** 1/2" NPT  
**K-Factor:** 3.3 U.S. (47.5 metric)

**LEGEND**  
 10 P.S.I. - - - - -  
 20 P.S.I. ······  
 30 P.S.I. - · - · -  
 50 P.S.I. \_\_\_\_\_

Top View-Horizontal Spray

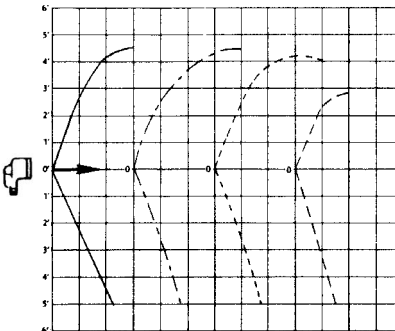

Side View-Horizontal Spray

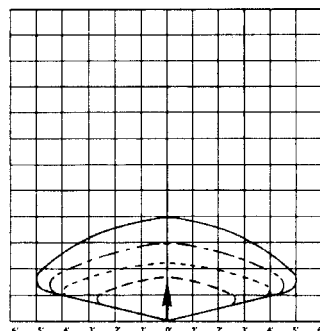

Side View Spray Up

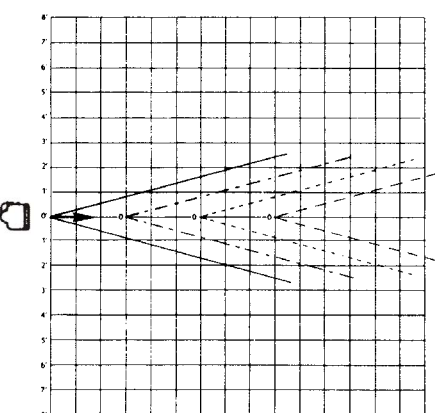

**Spray Nozzle Model:**  
 C2 (VK770-VK774†)  
**Spray Nozzle Base P/Ns:**  
 19505A & 19505J\*  
**Angle:** 30°  
**Thread Size:** 1/2" NPT  
**K-Factor:** 3.3 U.S. (47.5 metric)

**LEGEND**  
 10 P.S.I. - - - - -  
 20 P.S.I. ······  
 30 P.S.I. - · - · -  
 50 P.S.I. \_\_\_\_\_

Top View-Horizontal Spray

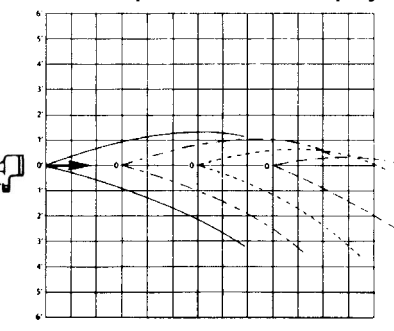

Side View-Horizontal Spray

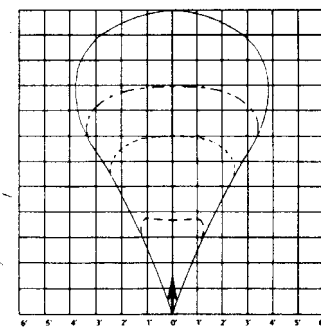

Side View Spray Up



TECHNICAL DATA

SOLID CONE SPRAY NOZZLES

The Viking Corporation, 210 N Industrial Park Drive, Hastings MI 49058  
 Telephone: 269-945-9501 Technical Services: 877-384-5464 Fax: 269-818-1680 Email: techsvcs@vikingcorp.com  
 Visit the Viking website for the latest edition of this technical data page.

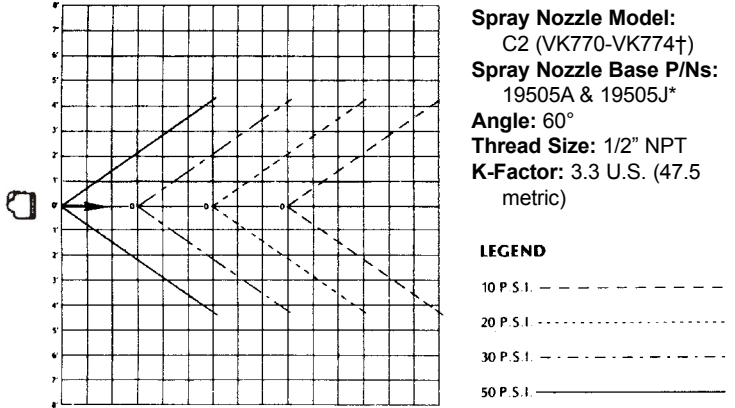

Top View-Horizontal Spray

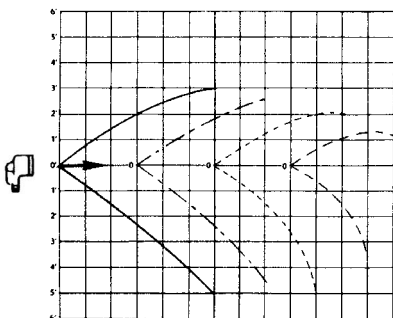

Side View-Horizontal Spray

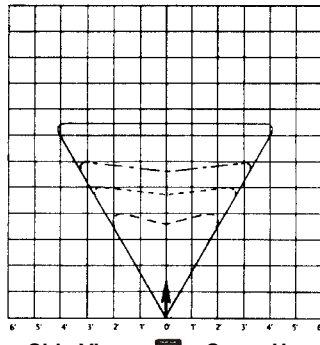

Side View Spray Up

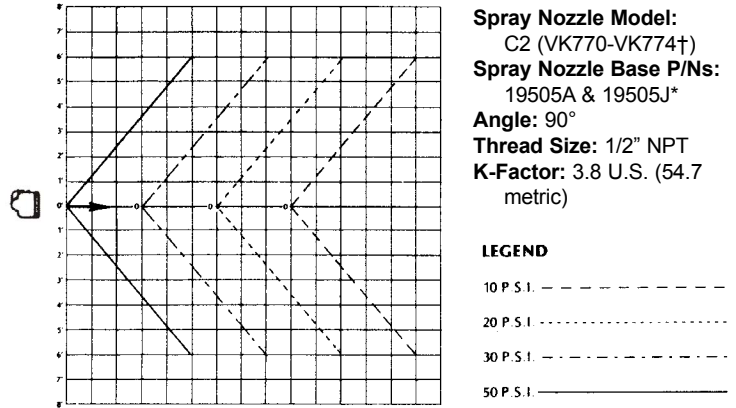

Top View-Horizontal Spray

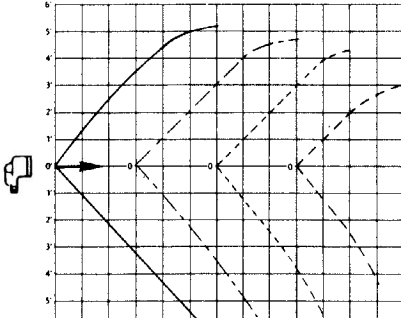

Side View-Horizontal Spray

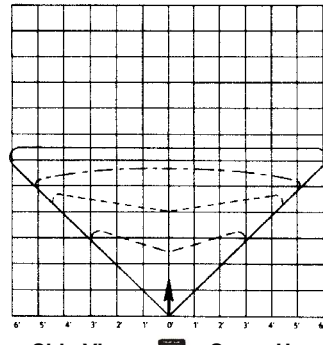

Side View Spray Up

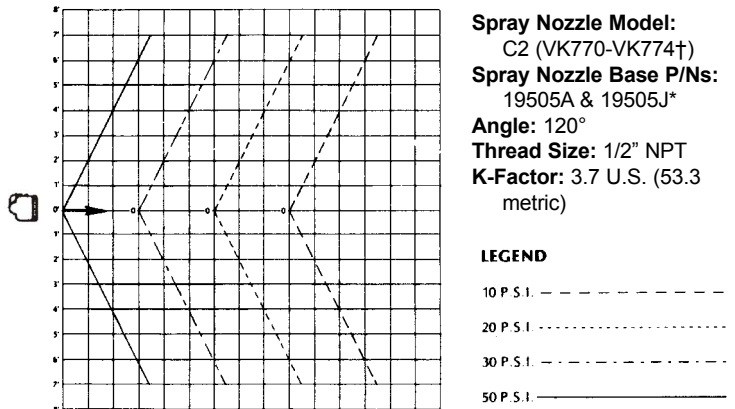

Top View-Horizontal Spray

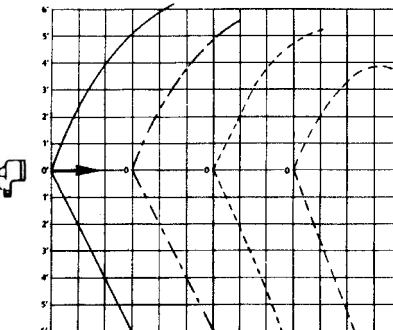

Side View-Horizontal Spray

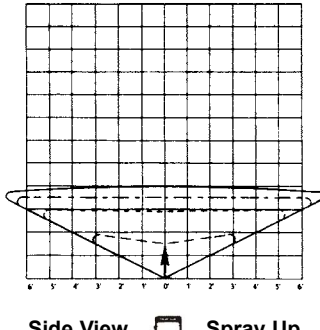

Side View Spray Up

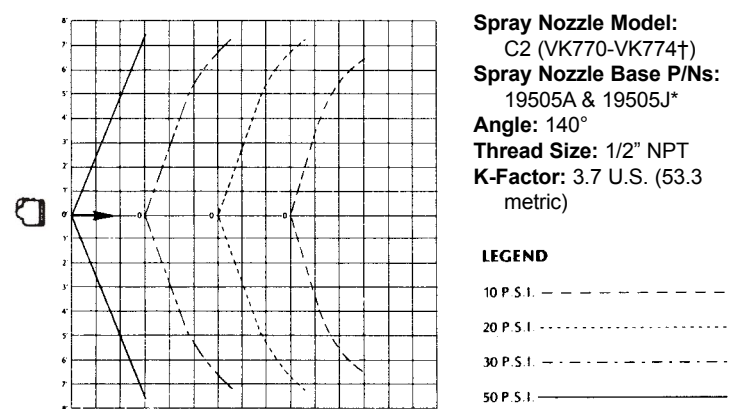

Top View-Horizontal Spray

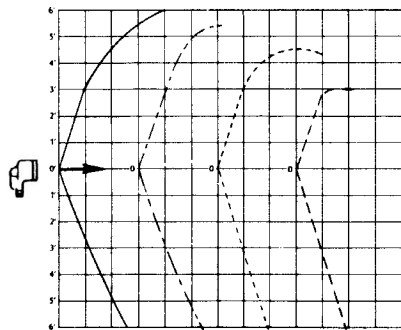

Side View-Horizontal Spray

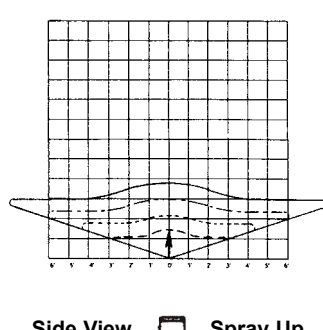

Side View Spray Up



TECHNICAL DATA

SOLID CONE SPRAY NOZZLES

The Viking Corporation, 210 N Industrial Park Drive, Hastings MI 49058  
 Telephone: 269-945-9501 Technical Services: 877-384-5464 Fax: 269-818-1680 Email: techsvcs@vikingcorp.com  
 Visit the Viking website for the latest edition of this technical data page.

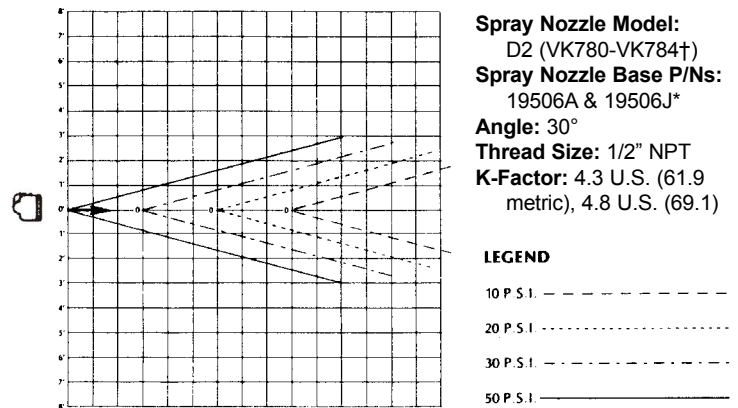

Top View-Horizontal Spray

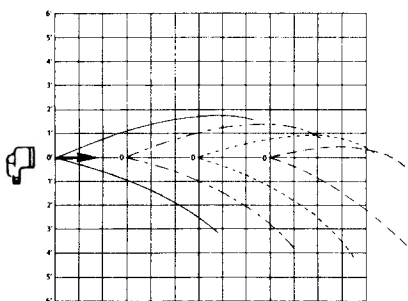

Side View-Horizontal Spray

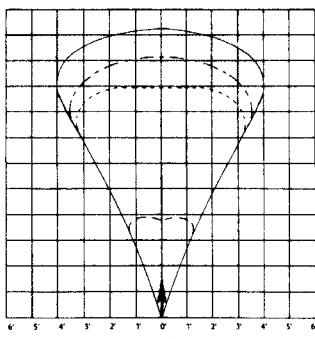

Side View Spray Up

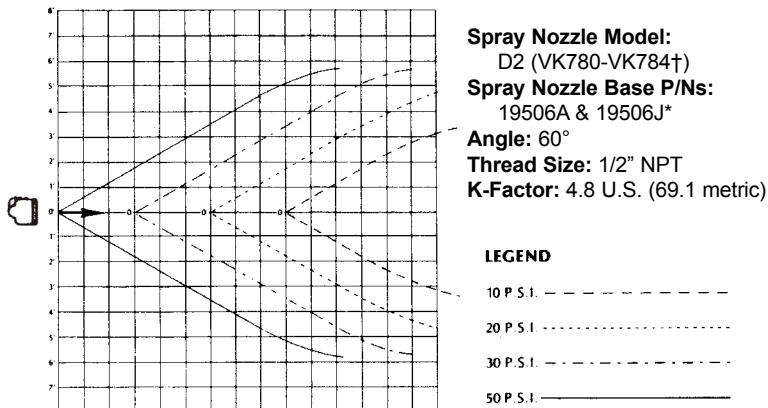

Top View-Horizontal Spray

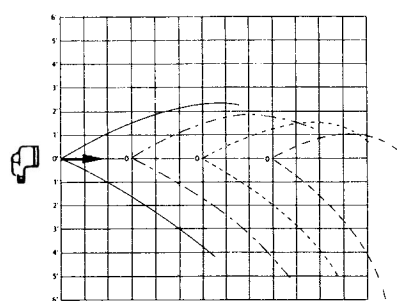

Side View-Horizontal Spray

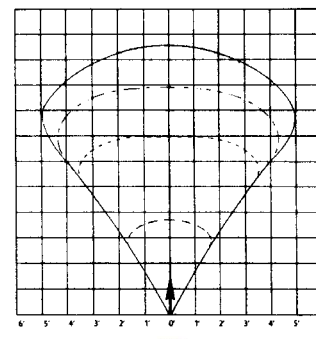

Side View Spray Up

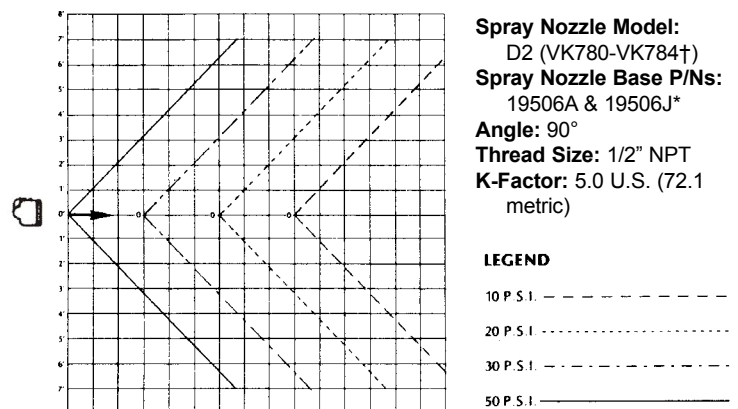

Top View-Horizontal Spray

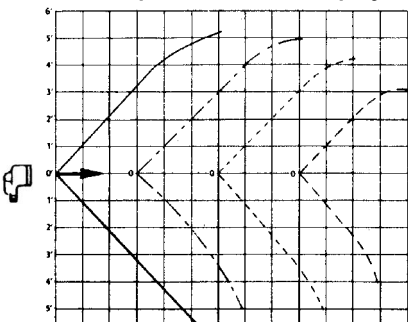

Side View-Horizontal Spray

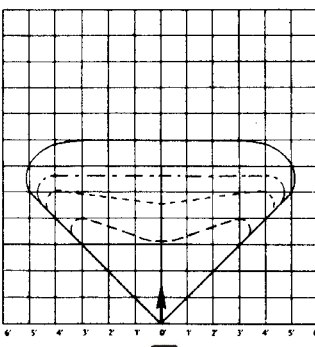

Side View Spray Up

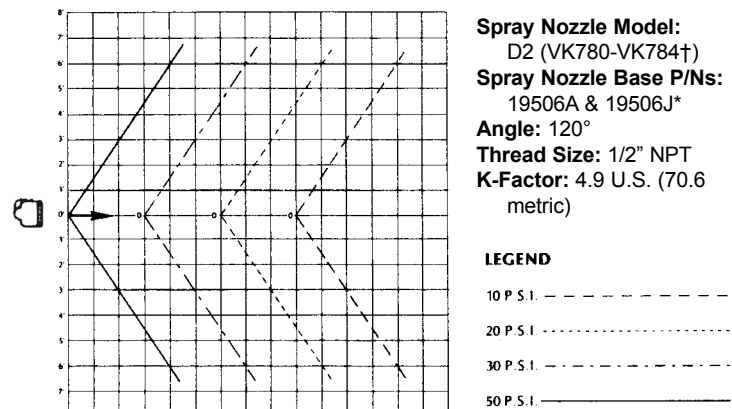

Top View-Horizontal Spray

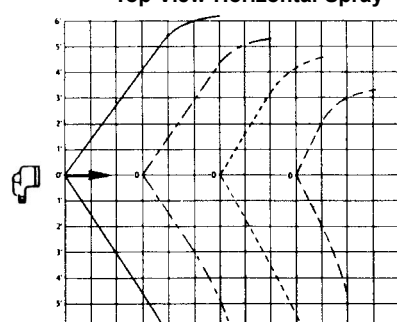

Side View-Horizontal Spray

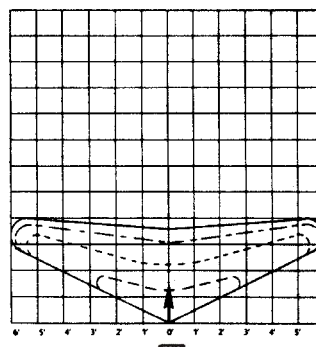

Side View Spray Up



**TECHNICAL DATA**

**SOLID CONE  
SPRAY NOZZLES**

The Viking Corporation, 210 N Industrial Park Drive, Hastings MI 49058  
 Telephone: 269-945-9501 Technical Services: 877-384-5464 Fax: 269-818-1680 Email: techsvcs@vikingcorp.com  
 Visit the Viking website for the latest edition of this technical data page.

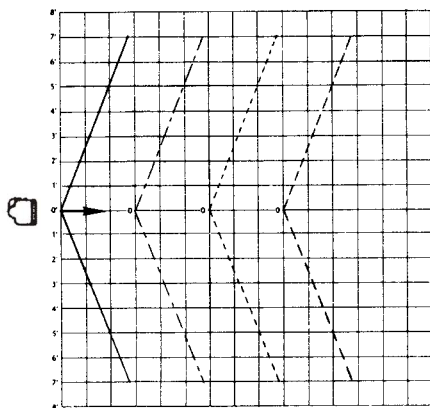

**Top View-Horizontal Spray**

**Spray Nozzle Model:**  
 D2 (VK780-VK784†)  
**Spray Nozzle Base P/Ns:**  
 19506A & 19506J\*  
**Angle:** 140°  
**Thread Size:** 1/2" NPT  
**K-Factor:** 4.9 U.S. (70.6 metric)

**LEGEND**

- 10 P.S.I. - - - - -
- 20 P.S.I. ······
- 30 P.S.I. - · - · - ·
- 50 P.S.I. —————

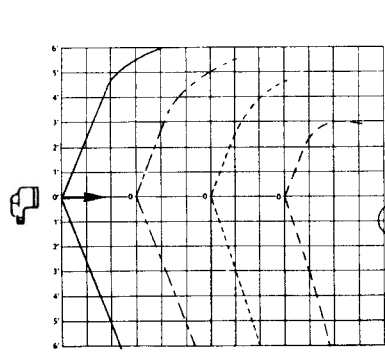

**Side View-Horizontal Spray**

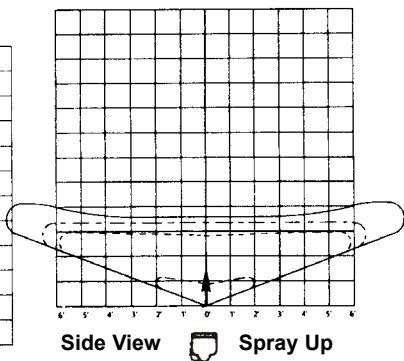

**Side View Spray Up**

Scale: Each square equals one square foot.

†Spray Nozzle Identification Numbers provided in accordance with the 1999 edition of NFPA 13, Section 3-2.2.

\* Base part numbers shown. For complete part number, refer to Viking's current price list.