



TABLE OF CONTENTS

ESFR	{ VK520 / VK500, 14.0 (202) K-factor, ESFR, upright / pendent..... D-1 VK503, 16.8 (242) K-factor, ESFR, pendent D-1 VK506, 22.4 (220) K-factor, ESFR, pendent D-1 VK510, 25.2 (363) K-factor, ESFR, pendent D-1 VK514, 28.0 (404) K-factor, ESFR, pendent D-1 VK502, 14.0 (202) K-factor, ESFR, <u>Dry Barrel</u> , pendent D-2 VK504, 16.8 (242) K-factor, ESFR, <u>Dry Barrel</u> , pendent D-2
Control Mode Specific Application	{ VK540, 11.2 (161) K-factor, large drop ELO, upright D-2 VK592, 19.6 (283) K-factor, control mode specific application, pendent..... D-2 VK598, 25.2 (363) K factor, storage/non-storage, specific application, upright..... D-3
Control Mode Density/Area	{ VK580, 16.8 (242) K-factor, density/area, upright D-3 VK598, 25.2 (360) K-factor, standard response, upright (FM storage sprinkler)..... D-3 VK530 / VK531, 11.2 (161) K-factor, special application, ELO, upright..... D-3 VK536 / VK377, 11.2 (161) K-factor, special application, ELO, upright / pendent D-4 VK533, 11.2 (161) K-factor, fusible link, special application, ELO, upright..... D-4
EC Storage	—VK595, 25.2 (363) K-factor, Extended Coverage, upright..... D-4
Intermediate Level	{ 5.6 (81) / 8.0 (115) K-factor, upright, (w/ shield), standard response (bulb/link) D-5 5.6 (81) / 8.0 (115) K-factor, upright, (w/ shield), quick response (bulb/link) D-5 5.6 (81) / 8.0 (115) K-factor, upright / pendent, (w/ guard), std response (bulb/link) . D-6 5.6 (81) / 8.0 (115) K-factor, upright / pendent, (w/ guard), quick resp. (bulb/link) D-7

Notes

1. Water shields and guards are also available separately. See page H-3.
2. Refer to Viking technical data pages for complete product specifications. You may print or download technical data by visiting www.vikinggroupinc.com.
3. List prices effective June 4, 2016. Supersedes May 2015 list price book.
4. All sales by Viking are subject to the Terms & Conditions found on the last page of this book.

High Challenge® is a registered trademark of The Viking Corporation
Micromatic® is a registered trademark of The Viking Corporation
Microfast® is a registered trademark of The Viking Corporation

	ESFR Storage Fusible Link Upright			
	<u>SIN:</u>	VK520		
	<u>K Factor:</u>	14.0 (202)		
	<u>Thread Size:</u>	3/4 inch NPT		
	<u>Base Part #:</u>	10625		
Finish	Temp	Part #	IPG	List Price
Standard Brass	165°F	10625AC	V24.1	\$126.73
Standard Brass	205°F	10625AE	V24.1	\$126.73
Spk Wrench Upright ESFR	05118CW/B		V20	\$141.46

	ESFR Storage Fusible Link Pendant			
	<u>SIN:</u>	VK500		
	<u>K Factor:</u>	14.0 (202)		
	<u>Thread Size:</u>	3/4 inch NPT		
	<u>Base Part #:</u>	10284		
Finish	Temp	Part #	IPG	List Price
Standard Brass	165°F	10284AC	V24	\$83.67
Standard Brass	205°F	10284AE	V24	\$83.67
Spk Wrench 14K ESFR	13635W/B		V20	\$122.38

	ESFR Storage Fusible Link Pendant			
	<u>SIN:</u>	VK503		
	<u>K Factor:</u>	16.8 (242)		
	<u>Thread Size:</u>	3/4 inch NPT		
	<u>Base Part #:</u>	14073		
Finish	Temp	Part #	IPG	List Price
Standard Brass	165°F	14073AC	V24.4	\$121.41
Standard Brass	205°F	14073AE	V24.4	\$121.41
Spk Wrench Pndnt ESFR	13635W/B		V20	\$122.38

	ESFR Storage Fusible Link Pendant			
	<u>SIN:</u>	VK506		
	<u>K Factor:</u>	22.4 (320)		
	<u>Thread Size:</u>	1 inch NPT		
	<u>Base Part #:</u>	18493		
Finish	Temp	Part #	IPG	List Price
Standard Brass	165°F	18493AC	V24.6	\$113.89
Standard Brass	205°F	18493AE	V24.6	\$113.89
Spk Wrench Pndnt ESFR	13635W/B		V20	\$122.38

	ESFR Storage Fusible Link Pendant			
	<u>SIN:</u>	VK510		
	<u>K Factor:</u>	25.2 (363)		
	<u>Thread Size:</u>	1 inch NPT		
	<u>Base Part #:</u>	12080		
Finish	Temp	Part #	IPG	List Price
Standard Brass	165°F	12080AC	V24.2	\$113.89
Standard Brass	205°F	12080AE	V24.2	\$113.89
Spk Wrench Pndnt ESFR	13635W/B		V20	\$122.38

	ESFR Storage Fusible Link Pendant			
	<u>SIN:</u>	VK514		
	<u>K Factor:</u>	28.0 (404)		
	<u>Thread Size:</u>	1 inch NPT		
	<u>Base Part #:</u>	19591		
Finish	Temp	Part #	IPG	List Price
Standard Brass	165°F	19591AC	V24.7	\$127.60
Standard Brass	205°F	19591AE	V24.7	\$127.60
Spk Wrench Pndnt ESFR	13635W/B		V20	\$122.38

ESFR Dry Pendant Sprinklers				
	ESFR - Dry Sprinkler^{1,2,3}			
	Fusible Link			
DRY SPRINKLER				
Pendent				
SIN:		VK502		
K Factor:		14.0 (202)		
Connection:				
Grooved		2 inch grooved		
Threaded		1-1/2 inch NPT		
Length - T/G	Temp	Part #	IPG	List Price
Standard Barrel Length - 36 in (953 mm)				
Grooved - 36"	165°F	18176AC	V19.1	\$1,317.62
Threaded - 36"	165°F	18177AC	V19.1	\$1,343.53
Additional Available Lengths				
Grooved - 18"	165°F	18702AC	V19.1	\$1,317.62
Threaded - 18"	165°F	18703AC	V19.1	\$1,343.53
Grooved - 24"	165°F	18706AC	V19.1	\$1,318.32
Threaded - 24"	165°F	18707AC	V19.1	\$1,317.62
Grooved - 30"	165°F	18710AC	V19.1	\$1,318.32
Threaded - 30"	165°F	18711AC	V19.1	\$1,343.53
ESFR - Dry Sprinkler^{1,2,3}				
	Fusible Link			
	DRY SPRINKLER			
Pendent				
SIN:		VK504		
K Factor:		16.8 (242)		
Connection:				
Grooved		1-1/2 inch grooved		
Threaded		1-1/2 inch NPT		
Connection	Temp	Part #	IPG	List Price
Standard Barrel Length - 36 in (953 mm)				
Grooved - 36"	165°F	19015AC	V19.3	\$1,365.19
Grooved - 36"	205°F	19015AE	V19.3	\$1,365.19
Threaded - 36"	165°F	19016AC	V19.3	\$1,413.94
Threaded - 36"	205°F	19016AE	V19.3	\$1,413.94
Additional Available Lengths				
Grooved - 18"	165°F	19225AC	V19.3	\$1,365.19
Grooved - 18"	205°F	19225AE	V19.3	\$1,365.19
Threaded - 18"	165°F	19226AC	V19.3	\$1,413.94
Threaded - 18"	205°F	19226AE	V19.3	\$1,413.94
Grooved - 24"	165°F	19229AC	V19.3	\$1,365.19
Grooved - 24"	205°F	19229AE	V19.3	\$1,365.19
Threaded - 24"	165°F	19230AC	V19.3	\$1,413.94
Threaded - 24"	205°F	19230AE	V19.3	\$1,413.94
Grooved - 30"	165°F	19233AC	V19.3	\$1,365.19
Grooved - 30"	205°F	19233AE	V19.3	\$1,365.19
Threaded - 30"	165°F	19234AC	V19.3	\$1,413.94
Threaded - 30"	205°F	19234AE	V19.3	\$1,413.94

Control Mode Specific Application Sprinklers				
	Control Mode Specific App.			
	Standard Response			
Fusible Link				
Pendent				
SIN:		VK592		
K Factor:		19.6 (283)		
Thread Size:		1 inch NPT		
Base Part #:		14243A		
Finish	Temp	Part #	IPG	List Price
Standard Brass	160°F	14243AC	V24.5	\$142.16
Standard Brass	205°F	14243AE	V24.5	\$142.16
Spk Wrench		13635W/B	V20	\$122.38

	High Challenge®			
	Large Drop			
ELO				
Glass Bulb				
Upright				
SIN:		VK540		
K Factor:		11.2 (161)		
Thread Size:		3/4 inch NPT		
Base Part #:		13167		
Finish	Temp	Part #	IPG	List Price
Standard Brass	155°F	13167AB	V20	\$80.67
Standard Brass	200°F	13167AE	V20	\$80.67
Standard Brass	286°F	13167AG	V20	\$80.67
Wrench High Challenge		05118CW/B	V20	\$141.46

FOR REPLACEMENT ONLY				
	High Challenge®			
	Large Drop			
ELO				
Glass Bulb				
Upright				
SIN:		VK540		
K Factor:		11.2 (161)		
Thread Size:		1/2 inch NPT		
Base Part #:		13166		
Finish	Temp	Part #	IPG	List Price
Standard Brass	155°F	13166AB	V20	\$80.67
Standard Brass	200°F	13166AE	V20	\$80.67
Standard Brass	286°F	13166AG	V20	\$80.67
Wrench High Challenge		05118CW/B	V20	\$141.46

(1) VK502 and VK504 can only be installed in wet systems
(2) Includes two dry sprinkler insulation boots (p/n 19330M/W)
(3) Dry ESFR sprinklers do not require a specific installation wrench. For grooved connection, use crescent wrench applied on grooved coupling. For threaded model, a pipe wrench applied on the inlet housing can be used.

	Control Mode			
	Standard Response			
	Density Area			
	Glass Bulb			
	Upright			
	SIN:	VK580		
K Factor:	16.8 (242)			
Thread Size:	3/4 inch NPT			
Base Part #:	12739			
Finish	Temp	Part #	IPG	List Price
Standard Brass	155°F	12739AB	V24.3	\$94.89
Standard Brass	175°F	12739AD	V24.3	\$94.89
Standard Brass	200°F	12739AE	V24.3	\$94.89
Standard Brass	286°F	12739AG	V24.3	\$94.89
Spk Wrench for 16.8K		07297W/B	V20	\$101.66

	FM Storage / Non-Storage			
	Standard Response			
	Standard Coverage			
	Glass Bulb			
	Upright			
	SIN:	VK598		
K Factor:	25.2 (363)			
Thread Size:	1 inch NPT			
Base Part #:	19522			
Finish	Temp	Part #	IPG	List Price
Standard Brass	155°F	19522AB	V24.8	\$167.38
Standard Brass	175°F	19522AD	V24.8	\$167.38
Standard Brass	200°F	19522AE	V24.8	\$167.38
Standard Brass	286°F	19522AG	V24.8	\$167.38
Spk Wrench Pndnt ESFR		13635W/B	V20	\$122.38

	Model-M ELO			
	Standard Response			
	Special Application			
	Glass Bulb			
	Upright			
	SIN:	VK530		
K Factor:	11.2 (161)			
Thread Size:	3/4 inch NPT			
Base Part #:	09679			
Finish	Temp	Part #	IPG	List Price
Standard Brass	155°F	09679AB	V18.2	\$53.94
Standard Brass	175°F	09679AD	V18.2	\$53.94
Standard Brass	200°F	09679AE	V18.2	\$53.94
Standard Brass	286°F	09679AG	V18.2	\$53.94
Chrome	155°F	09679FB	V18	\$58.65
Chrome	175°F	09679FD	V18	\$58.65
Chrome	200°F	09679FE	V18	\$58.65
Chrome	286°F	09679FG	V18	\$58.65
White-Polyester ¹	155°F	09679MB/W	V18	\$58.65
White-Polyester	175°F	09679MD/W	V18	\$58.65
White-Polyester	200°F	09679ME/W	V18	\$58.65
White-Polyester	286°F	09679MG/W	V18	\$58.65
Nickel PTFE (ENT) ²	155°F	09679JNB	V20.4	\$110.54
Nickel PTFE (ENT)	175°F	09679JND	V20.4	\$110.54
Nickel PTFE (ENT)	200°F	09679JNE	V20.4	\$110.54
Nickel PTFE (ENT)	286°F	09679JNG	V20.4	\$110.54
Nickel PTFE (ENT)	OPEN	09679JNZ	V20.4	\$110.54
Wax Coated ³	155°F	09679CB	V18	\$65.91
Wax Coated	175°F	09679CD	V18	\$65.91
Wax Coated	200°F	09679CE	V18	\$65.91
Wax Coated	286°F	09679CG	V18	\$65.91
Spk Wrench Upright ELO		05118CW/B	V20	\$141.46

	Model-M ELO			
	Quick Response			
	Special Application			
	Glass Bulb			
	Upright			
	SIN:	VK531		
K Factor:	11.2 (161)			
Thread Size:	3/4 inch NPT			
Base Part #:	10633			
Finish	Temp	Part #	IPG	List Price
Standard Brass	155°F	10633AB	V18.2	\$76.17
Standard Brass	175°F	10633AD	V18.2	\$76.17
Standard Brass	200°F	10633AE	V18.2	\$76.17
Standard Brass	286°F	10633AG	V18.2	\$76.17
Chrome	155°F	10633FB	V18	\$80.67
Chrome	175°F	10633FD	V18	\$80.67
Chrome	200°F	10633FE	V18	\$80.67
Chrome	286°F	10633FG	V18	\$80.67
White-Polyester ¹	155°F	10633MB/W	V18	\$80.67
White-Polyester	175°F	10633MD/W	V18	\$80.67
White-Polyester	200°F	10633ME/W	V18	\$80.67
White-Polyester	286°F	10633MG/W	V18	\$80.67
Nickel PTFE (ENT) ²	155°F	10633JNB	V20.4	\$116.68
Nickel PTFE (ENT)	175°F	10633JND	V20.4	\$116.68
Nickel PTFE (ENT)	200°F	10633JNE	V20.4	\$116.68
Nickel PTFE (ENT)	286°F	10633JNG	V20.4	\$116.68
Nickel PTFE (ENT)	OPEN	10633JNZ	V20.4	\$116.68
Wax Coated ³	155°F	10633CB	V18	\$87.82
Wax Coated	175°F	10633CD	V18	\$87.82
Wax Coated	200°F	10633CE	V18	\$87.82
Wax Coated	286°F	10633CG	V18	\$87.82
Spk Wrench Upright ELO		05118CW/B	V20	\$141.46

(1) Suitable for decorative applications and are UL listed for corrosion resistance.
(2) Electroless Nickel PTFE (ENT) plating is UL Listed and FM Approved for corrosion resistance.
(3) Brass is the standard finish for wax coated sprinklers.

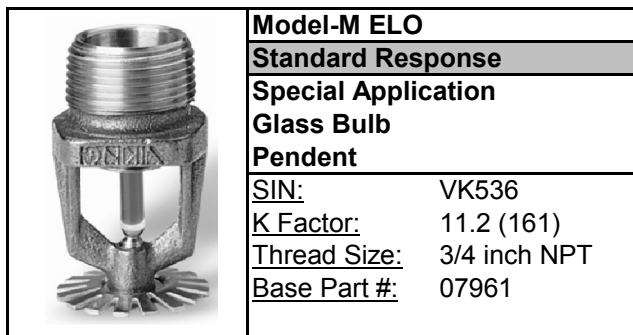

Model-M ELO
Standard Response
Special Application
Glass Bulb
Pendent
SIN: VK536
K Factor: 11.2 (161)
Thread Size: 3/4 inch NPT
Base Part #: 07961

Finish	Temp	Part #	IPG	List Price
Standard Brass	155°F	07961AB	V18.2	\$53.94
Standard Brass	175°F	07961AD	V18.2	\$53.94
Standard Brass	200°F	07961AE	V18.2	\$53.94
Standard Brass	286°F	07961AG	V18.2	\$53.94
Chrome	155°F	07961FB	V18	\$58.65
Chrome	175°F	07961FD	V18	\$58.65
Chrome	200°F	07961FE	V18	\$58.65
Chrome	286°F	07961FG	V18	\$58.65
White-Polyester ¹	155°F	07961MB/W	V18	\$58.65
White-Polyester	175°F	07961MD/W	V18	\$58.65
White-Polyester	200°F	07961ME/W	V18	\$58.65
White-Polyester	286°F	07961MG/W	V18	\$58.65
Nickel PTFE (ENT) ²	155°F	07961JNB	V20.4	\$110.54
Nickel PTFE (ENT)	175°F	07961JND	V20.4	\$110.54
Nickel PTFE (ENT)	200°F	07961JNE	V20.4	\$110.54
Nickel PTFE (ENT)	286°F	07961JNG	V20.4	\$110.54
Spk Wrench Pendent ELO		05118CW/B	V20	\$141.46

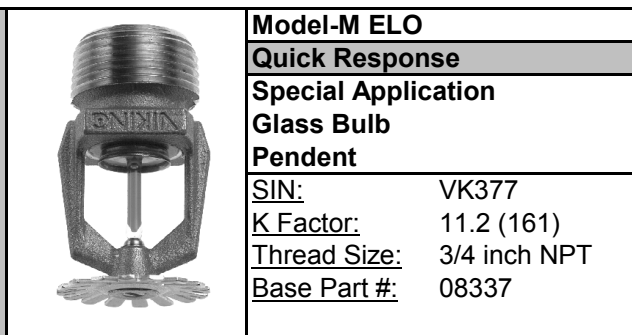

Model-M ELO
Quick Response
Special Application
Glass Bulb
Pendent
SIN: VK377
K Factor: 11.2 (161)
Thread Size: 3/4 inch NPT
Base Part #: 08337

Finish	Temp	Part #	IPG	List Price
Standard Brass	155°F	08337AB	V18.2	\$76.17
Standard Brass	175°F	08337AD	V18.2	\$76.17
Standard Brass	200°F	08337AE	V18.2	\$76.17
Standard Brass	286°F	08337AG	V18.2	\$76.17
Chrome	155°F	08337FB	V18	\$80.67
Chrome	175°F	08337FD	V18	\$80.67
Chrome	200°F	08337FE	V18	\$80.67
Chrome	286°F	08337FG	V18	\$80.67
White-Polyester ¹	155°F	08337MB/W	V18	\$80.67
White-Polyester	175°F	08337MD/W	V18	\$80.67
White-Polyester	200°F	08337ME/W	V18	\$80.67
White-Polyester	286°F	08337MG/W	V18	\$80.67
Nickel PTFE (ENT) ²	155°F	08337JNB	V20.4	\$116.68
Nickel PTFE (ENT)	175°F	08337JND	V20.4	\$116.68
Nickel PTFE (ENT)	200°F	08337JNE	V20.4	\$116.68
Nickel PTFE (ENT)	286°F	08337JNG	V20.4	\$116.68
Spk Wrench Pendent ELO		05118CW/B	V20	\$141.46

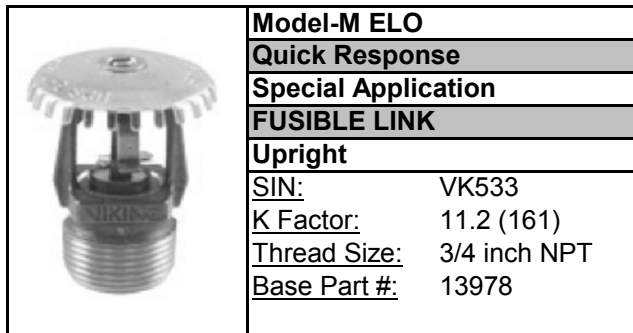

Model-M ELO
Quick Response
Special Application
FUSIBLE LINK
Upright
SIN: VK533
K Factor: 11.2 (161)
Thread Size: 3/4 inch NPT
Base Part #: 13978

Finish	Temp	Part #	IPG	List Price
Standard Brass	165°F	13978AC	V18.2	\$89.93
Standard Brass	205°F	13978AE	V18.2	\$89.93
Standard Brass	280°F	13978AG	V18.2	\$89.93
Chrome	165°F	13978FC	V18	\$88.68
Chrome	205°F	13978FE	V18	\$88.68
Chrome	280°F	13978FG	V18	\$88.68
White-Polyester ¹	165°F	13978MC/W	V18	\$88.68
White-Polyester	205°F	13978ME/W	V18	\$88.68
White-Polyester	280°F	13978MG/W	V18	\$88.68
Spk Wrench Upright ELO		05118CW/B	V20	\$141.46

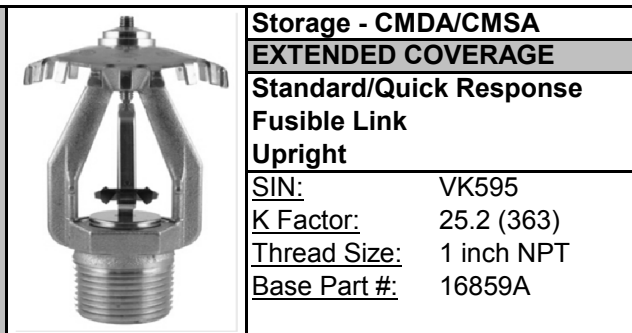

Storage - CMDA/CMSA
EXTENDED COVERAGE
Standard/Quick Response
Fusible Link
Upright
SIN: VK595
K Factor: 25.2 (363)
Thread Size: 1 inch NPT
Base Part #: 16859A

Finish	Temp	Part #	IPG	List Price
Standard Brass	165°F	16859AC	V18.3	\$142.38
Standard Brass	212°F	16859AE	V18.3	\$142.38
Spk Wrench		16888M/B	V20	\$149.55

(1) Suitable for decorative applications and are UL listed for corrosion resistance.

(2) Electroless Nickel PTFE (ENT) plating is UL Listed and FM Approved for corrosion resistance.

	Micromatic® Model M			
	Intermediate Level / In-Rack			
	Preassembled w/ Shield			
	Standard Response			
	Glass Bulb Upright			
SIN:		VK550		
K Factor:		5.6 (81)		
Thread Size:		1/2 inch NPT		
Base Part #:		12986--U		
Finish	Temp	Part #	IPG	List Price
Standard Brass	155°F	12986ABU	V20.1	\$25.81
Standard Brass	175°F	12986ADU	V20.1	\$25.81
Standard Brass	200°F	12986AEU	V20.1	\$25.81
Standard Brass	286°F	12986AGU	V20.1	\$25.81
Standard Brass	360°F	12986AHU	V20.1	\$28.48
Std Sprinkler Wrench		10896W/B	V20	\$67.72

FUSIBLE LINK - VK552 - 5.6 (81) K Factor - SR Upright				
Standard Brass	165°F	12973ACU	V20.1	\$35.30
Standard Brass	220°F	12973AFU	V20.1	\$35.30
Standard Brass	286°F	12973AGU	V20.1	\$35.30
Std Sprinkler Wrench		10896W/B	V20	\$67.72

	Microfast® Model M			
	Intermediate Level / In-Rack			
	Preassembled w/ Shield			
	Quick Response			
	Glass Bulb Upright			
SIN:		VK556		
K Factor:		5.6 (81)		
Thread Size:		1/2 inch NPT		
Base Part #:		12978--U		
Finish	Temp	Part #	IPG	List Price
Standard Brass	155°F	12978ABU	V20.1	\$39.53
Standard Brass	175°F	12978ADU	V20.1	\$39.53
Standard Brass	200°F	12978AEU	V20.1	\$39.53
Standard Brass	286°F	12978AGU	V20.1	\$39.53
HIGH PRESSURE (VK558 - p/n 12281--U)				
Standard Brass	155°F	12281ABU	V20.1	\$41.01
Standard Brass	175°F	12281ADU	V20.1	\$41.01
Standard Brass	200°F	12281AEU	V20.1	\$41.01
Standard Brass	286°F	12281AGU	V20.1	\$41.01
FUSIBLE LINK - VK551 - 5.6 (81) K Factor - QR Upright				
Standard Brass	205°F	12279AEU	V20.1	\$51.83
Standard Brass	280°F	12279AGU	V20.1	\$51.83
Std Sprinkler Wrench		10896W/B	V20	\$67.72

	Micromatic® Model M			
	Intermediate Level / In-Rack			
	Preassembled w/ Shield			
	Standard Response			
	Glass Bulb Upright			
SIN:		VK560		
K Factor:		8.0 (115)		
Thread Size:		3/4 inch NPT		
Base Part #:		18263--U		
Finish	Temp	Part #	IPG	List Price
Standard Brass	155°F	18263ABU	V20.1	\$29.63
Standard Brass	175°F	18263ADU	V20.1	\$29.63
Standard Brass	200°F	18263AEU	V20.1	\$29.63
Standard Brass	286°F	18263AGU	V20.1	\$29.63
Standard Brass	360°F	18263AHU	V20.1	\$32.27

1/2 inch NPT (10220) - REPLACEMENT ONLY				
Standard Brass	155°F	18268ABU	V20.1	\$31.06
Standard Brass	175°F	18268ADU	V20.1	\$31.06
Standard Brass	200°F	18268AEU	V20.1	\$31.06
Standard Brass	212°F	18268AMU	V20.1	\$31.06
Standard Brass	286°F	18268AGU	V20.1	\$31.06
Standard Brass	360°F	18268AHU	V20.1	\$33.70

FUSIBLE LINK - VK562 - 8.0 (110) K Factor - SR Upright				
Standard Brass	165°F	18253ACU	V20.1	\$37.64
Standard Brass	220°F	18253AFU	V20.1	\$37.64
Standard Brass	286°F	18253AGU	V20.1	\$37.64
Std Sprinkler Wrench		10896W/B	V20	\$67.72

	Microfast® Model M			
	Intermediate Level / In-Rack			
	Preassembled w/ Shield			
	Quick Response			
	Glass Bulb Upright			
SIN:		VK566		
K Factor:		8.0 (115)		
Thread Size:		3/4 inch NPT		
Base Part #:		18257--U		
Finish	Temp	Part #	IPG	List Price
Standard Brass	155°F	18257ABU	V20.1	\$43.92
Standard Brass	175°F	18257ADU	V20.1	\$43.92
Standard Brass	200°F	18257AEU	V20.1	\$43.92
Standard Brass	286°F	18257AGU	V20.1	\$43.92

FUSIBLE LINK - VK567 - 8.0 (110) K Factor - QR Upright				
Standard Brass	165°F	18275ACU	V20.1	\$49.82
Standard Brass	205°F	18275AEU	V20.1	\$49.82
Standard Brass	280°F	18275AGU	V20.1	\$49.82
Std Sprinkler Wrench		10896W/B	V20	\$67.72





	Micromatic® Model M			
	Intermediate Level / In-Rack			
	Preassembled w/ Guard			
	Standard Response			
	Glass Bulb Upright			
SIN:		VK100		
K Factor:		5.6 (81)		
Thread Size:		1/2 inch NPT		
Base Part #:		12986--G		
Finish	Temp	Part #	IPG	List Price
Standard Brass	155°F	12986ABG	V20.1	\$30.30
Standard Brass	175°F	12986ADG	V20.1	\$30.30
Standard Brass	200°F	12986AEG	V20.1	\$30.30
Standard Brass	212°F	12986AMG	V20.1	\$30.30
Standard Brass	286°F	12986AGG	V20.1	\$30.30
Standard Brass	360°F	12986AHG	V20.1	POA
FUSIBLE LINK - VK108 - 5.6 (81) K Factor - SR Upright				
Standard Brass	165°F	12973ACG	V20.1	\$36.90
Standard Brass	220°F	12973AFG	V20.1	\$36.90
Standard Brass	286°F	12973AGG	V20.1	\$36.90
Std Sprinkler Wrench		10896W/B	V20	\$67.72

	Micromatic® Model M			
	Intermediate Level / In-Rack			
	Preassembled w/ Guard			
	Standard Response			
	Glass Bulb Pendant			
SIN:		VK102		
K Factor:		5.6 (81)		
Thread Size:		1/2 inch NPT		
Base Part #:		12987--G		
Finish	Temp	Part #	IPG	List Price
Standard Brass	155°F	12987ABG	V20.1	\$30.92
Standard Brass	175°F	12987ADG	V20.1	\$30.92
Standard Brass	200°F	12987AEG	V20.1	\$30.92
Standard Brass	212°F	12987AMG	V20.1	\$30.92
Standard Brass	286°F	12987AGG	V20.1	\$30.92
Standard Brass	360°F	12987AHG	V20.1	POA
FUSIBLE LINK - VK110 - 5.6 (81) K Factor - SR Pendant				
Standard Brass	165°F	12972ACG	V20.1	\$36.90
Standard Brass	220°F	12972AFG	V20.1	\$36.90
Standard Brass	286°F	12972AGG	V20.1	\$36.90
Std Sprinkler Wrench		10896W/B	V20	\$67.72

	Micromatic® Model M			
	Intermediate Level / In-Rack			
	Preassembled w/ Guard			
	Standard Response			
	Glass Bulb Upright			
SIN:		VK200		
K Factor:		8.0 (115)		
Thread Size:		3/4 inch NPT		
Base Part #:		18263--G		
Finish	Temp	Part #	IPG	List Price
Standard Brass	155°F	18263ABG	V20.1	\$34.00
Standard Brass	175°F	18263ADG	V20.1	\$34.00
Standard Brass	200°F	18263AEG	V20.1	\$34.00
Standard Brass	212°F	18263AMG	V20.1	\$34.00
Standard Brass	286°F	18263AGG	V20.1	\$34.00
Standard Brass	360°F	18263AHG	V20.1	POA
FUSIBLE LINK - VK204 - 8.0 (115) K Factor - SR Upright				
Standard Brass	165°F	18253ACG	V20.1	\$36.98
Standard Brass	220°F	18253AFG	V20.1	\$36.98
Standard Brass	286°F	18253AGG	V20.1	\$36.98
Std Sprinkler Wrench		10896W/B	V20	\$67.72

	Micromatic® Model M			
	Intermediate Level / In-Rack			
	Preassembled w/ Guard			
	Standard Response			
	Glass Bulb Pendant			
SIN:		VK202		
K Factor:		8.0 (115)		
Thread Size:		3/4 inch NPT		
Base Part #:		18264--G		
Finish	Temp	Part #	IPG	List Price
Standard Brass	155°F	18264ABG	V20.1	\$40.59
Standard Brass	175°F	18264ADG	V20.1	\$40.59
Standard Brass	200°F	18264AEG	V20.1	\$40.59
Standard Brass	212°F	18264AMG	V20.1	\$40.59
Standard Brass	286°F	18264AGG	V20.1	\$40.59
Standard Brass	360°F	18264AHG	V20.1	POA
FUSIBLE LINK - VK206 - 8.0 (115) K Factor - SR Pendant				
Standard Brass	165°F	18254ACG	V20.1	\$38.73
Standard Brass	220°F	18254AFG	V20.1	\$38.73
Standard Brass	286°F	18254AGG	V20.1	\$38.73
Std Sprinkler Wrench		10896W/B	V20	\$67.72

For intermediate level sprinklers preassembled with guard, the Model F-1 water shield may be ordered separately. Shield must be installed in field (not available preassembled)

	<i>upright</i>		<i>pendent</i>		Model E-1 UPRIGHT Water Shield			
					Size	Part #	IPG	List Price
					1/2 "	10326	V20.1	\$6.15
					3/4 "	10326	V20.1	\$6.15
					Model F-1 PENDENT Water Shield			
					Size	Part #	IPG	List Price
					1/2 "	10323	V20.1	\$6.15
					3/4 "	10324	V20.1	\$6.15

NOTE - Sprinkler guards are also available separately (see page H-3).

* also available in stainless steel (see page H-3)



Microfast® Model M
Intermediate Level / In-Rack
Preassembled w/ Guard
Quick Response
Glass Bulb
Upright
SIN: VK300
K Factor: 5.6 (81)
Thread Size: 1/2 inch NPT
Base Part #: 12978--G

Finish	Temp	Part #	IPG	List Price
Standard Brass	155°F	12978ABG	V20.1	\$39.41
Standard Brass	175°F	12978ADG	V20.1	\$39.41
Standard Brass	200°F	12978AEG	V20.1	\$39.41
Standard Brass	286°F	12978AGG	V20.1	\$39.41
HIGH PRESSURE (VK315 - p/n 12281--G)				
Standard Brass	155°F	12281ABG	V20.1	\$40.96
Standard Brass	175°F	12281ADG	V20.1	\$40.96
Standard Brass	200°F	12281AEG	V20.1	\$40.96
Standard Brass	286°F	12281AGG	V20.1	\$40.96
FUSIBLE LINK - VK204 - 5.6 (81) K Factor - QR Upright				
Standard Brass	165°F	05514ACG	V20.1	\$36.98
Standard Brass	220°F	05514AFG	V20.1	\$36.98
Standard Brass	286°F	05514AGG	V20.1	\$36.98
Std Sprinkler Wrench		10896W/B	V20	\$67.72



Microfast® Model M
Intermediate Level / In-Rack
Preassembled w/ Guard
Quick Response
Glass Bulb
Pendent
SIN: VK302
K Factor: 5.6 (81)
Thread Size: 1/2 inch NPT
Base Part #: 12979--G

Finish	Temp	Part #	IPG	List Price
Standard Brass	155°F	12979ABG	V20.1	\$41.81
Standard Brass	175°F	12979ADG	V20.1	\$41.81
Standard Brass	200°F	12979AEG	V20.1	\$41.81
Standard Brass	286°F	12979AGG	V20.1	\$41.81
HIGH PRESSURE (VK317 - p/n 12282)				
Standard Brass	155°F	12282ABG	V20.1	\$43.38
Standard Brass	175°F	12282ADG	V20.1	\$43.38
Standard Brass	200°F	12282AEG	V20.1	\$43.38
Standard Brass	286°F	12282AGG	V20.1	\$43.38
FUSIBLE LINK - VK303 - 5.6 (81) K Factor - QR Pendent				
Standard Brass	165°F	17536ACG	V20.1	\$48.81
Standard Brass	220°F	17536AFG	V20.1	\$48.81
Standard Brass	286°F	17536AGG	V20.1	\$48.81
Std Sprinkler Wrench		10896W/B	V20	\$67.72



Microfast® Model M
Intermediate Level / In-Rack
Preassembled w/ Guard
Quick Response
Glass Bulb
Upright
SIN: VK350
K Factor: 8.0 (115)
Thread Size: 3/4 inch NPT
Base Part #: 18257--G



Finish	Temp	Part #	IPG	List Price
Standard Brass	155°F	18257ABG	V20.1	\$51.39
Standard Brass	175°F	18257ADG	V20.1	\$51.39
Standard Brass	200°F	18257AEG	V20.1	\$51.39
Standard Brass	286°F	18257AGG	V20.1	\$51.39
Std Sprinkler Wrench		10896W/B	V20	\$67.72



Microfast® Model M
Intermediate Level / In-Rack
Preassembled w/ Guard
Quick Response
Glass Bulb
Pendent
SIN: VK352
K Factor: 8.0 (115)
Thread Size: 3/4 inch NPT
Base Part #: 18258--G

Finish	Temp	Part #	IPG	List Price
Standard Brass	155°F	18258ABG	V20.1	\$49.21
Standard Brass	175°F	18258ADG	V20.1	\$49.21
Standard Brass	200°F	18258AEG	V20.1	\$49.21
Standard Brass	286°F	18258AGG	V20.1	\$49.21
Std Sprinkler Wrench		10896W/B	V20	\$67.72

For intermediate level sprinklers preassembled with guard, the Model F-1 water shield may be ordered separately. Shield must be installed in field (not available preassembled)

optional water shields	field installed shield	field installed shield	Model E-1 UPRIGHT Water Shield			
Model E-1 (upright)	upright	pendent	Size	Part #	IPG	List Price
			1/2"	10326	V20.1	\$6.15
Model F-1 (pendent)			3/4"	10326	V20.1	\$6.15
			Model F-1 PENDENT Water Shield			
			Size	Part #	IPG	List Price
			1/2"	10323	V20.1	\$6.15
			3/4"	10324	V20.1	\$6.15

NOTE - Sprinkler guards are also available separately (see page H-3).

* also available in stainless steel (see page H-3)