



Maxim™ Series M300, M300N

Double Check Detector Assemblies

Sizes: 2 1/2" – 10" (65 – 250mm)



300 BFG



M300 OSY

Features

- Extremely Compact Design
- 70% Lighter than Traditional Designs
- 304 (Schedule 40) Stainless Steel Housing & Sleeve
- Groove Fittings Allow Integral Pipeline Adjustment
- Patented Tri-Link Check Provides Lowest Pressure Loss
- Unmatched Ease of Serviceability
- Available with Grooved Butterfly Valve Shutoffs
- Available for Horizontal, Vertical or N Pattern Installations
- Replaceable Check Disc Rubber

The Maxim M300, M300N Double Check Detector Assemblies are designed to protect drinking water supplies from dangerous cross-connections in accordance with national plumbing codes and water authority requirements for non-health hazard non-potable service applications such as irrigation, fire line, or industrial processing. The Maxim M300, M300N may be installed under continuous pressure service and may be subjected to backpressure. The Maxim M300, M300N are used primarily on fire line sprinkler systems when it is necessary to monitor unauthorized use of water.

Specifications

The Double Check Detector Assemblies shall consist of two independent Tri-Link Check modules within a single housing, sleeve access port, four test cocks and two drip tight shutoff valves. Tri-Link Checks shall be removable and serviceable, without the use of special tools. The housing shall be constructed of 304 (Schedule 40) stainless steel pipe with groove end connections. Tri-Link Checks shall have reversible elastomer discs and in operation shall produce drip tight closure against the reverse flow of liquid caused by backpressure or backsiphonage. The bypass assembly consists of a meter registering either gallon or cubic measurements, a double check valve assembly and required test cocks. Assembly shall be a Maxim M300, M300N as manufactured by the Ames Company.

⚠ WARNING

It is illegal to use this product in any plumbing system providing water for human consumption, such as drinking or dishwashing, in the United States. Before installing standard material product, consult your local water authority, building and plumbing codes.

NOTICE

The information contained herein is not intended to replace the full product installation and safety information available or the experience of a trained product installer. You are required to thoroughly read all installation instructions and product safety information before beginning the installation of this product.

Job Name _____ Contractor _____

Job Location _____ Approval _____

Engineer _____ Contractor's P.O. No. _____

Approval _____ Representative _____

Configurations

- Horizontal
- Vertical up
- “N” pattern horizontal

Materials

- Housing & Sleeve: 304 (Schedule 40) Stainless Steel
- Elastomers: EPDM, Silicone and Buna ‘N’
- Tri-Link Checks: Noryl®, Stainless Steel
- Check Discs: Reversible Silicone or EPDM
- Test Cocks: Bronze Body Nickel Plated
- Pins & Fasteners: 300 Series Stainless Steel
- Springs: Stainless Steel

Available Models

OSY - UL/FM flanged outside stem and yoke resilient seated gate valves

BFG - UL/FM grooved gear operated butterfly valves w/tamper switch

*OSY FxG - Flanged inlet gate connection and grooved outlet gate connection

*OSY GxF - Grooved inlet gate connection and flanged outlet gate connection

*OSY GxG - Grooved inlet gate connection and grooved outlet gate connection

Available with grooved NRS gate valves - consult factory*

Post indicator plate and operating nut available - consult factory*

*Consult factory for dimensions

Pressure — Temperature

Temperature Range: 33°F – 110°F (5°C – 43°C)

Maximum Working Pressure: 175psi (12.06 bar)

Dimensions — Weights

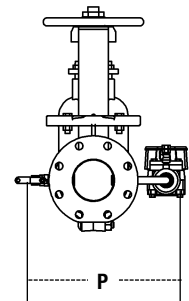
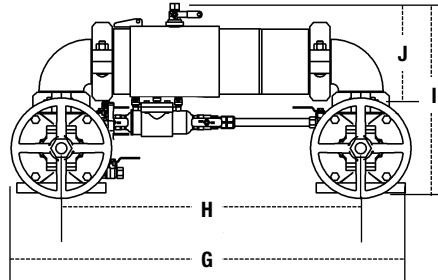
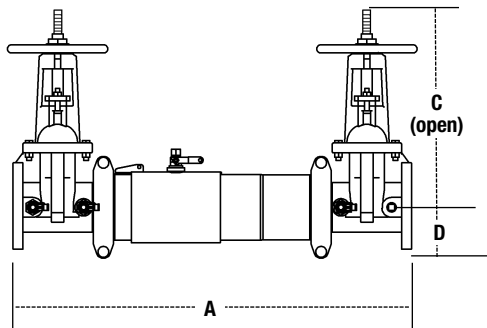

M300, M300N

SIZE (DN)		DIMENSIONS														WEIGHT					
in	mm	A		C (OSY)		D		G		H		I		J		P		M300		M300N	
		in	mm	in	mm	in	mm	in	mm	in	mm	in	mm	in	mm	in	mm	lbs.	kgs.	lbs.	kgs.
2½	65	30¾	781	16¾	416	3½	89	29⅛	738	21½	546	15⅓	402	8⅓	223	13⅓	335	139	63	147	67
3	80	31¾	806	18⅞	479	3⅛	94	30½	775	22¼	565	17⅛	435	9⅞	233	14½	368	159	72	172	78
4	100	40½	1029	22¾	578	5	127	39¾	1010	30¼	768	20⅞	518	11⅛	297	15⅞	386	233	106	256	116
6	150	47¾	1213	30⅞	765	6½	165	40	1016	37½	953	24¾	629	14⅞	360	19½	495	404	183	444	201
8	200	54¾	1391	37¾	959	7½	191	59⅞	1502	45⅞	1146	28⅞	721	16¾	425	21½	546	578	262	654	297
10	250	57¾	1467	45¾	1162	8⅞	208	66	1676	49½	1257	32½	826	17⅞	440	24	610	795	361	965	438

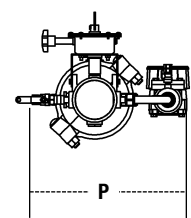
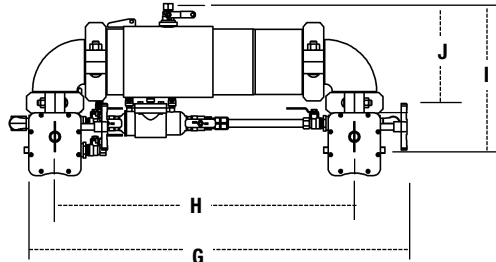
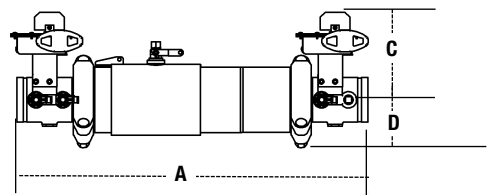

M300BFG, M300NBFG

SIZE (DN)		DIMENSIONS														WEIGHT					
in.	mm	A		C		D		G		H		I		J		P		M300BFG		M300NBFG	
		in.	mm	in.	mm	in.	mm	in.	mm	in.	mm	in.	mm	in.	mm	in.	mm	lbs.	kgs.	lbs.	kgs.
2½	65	27¾	705	8	203	3½	89	29⅞	759	21½	546	14⅓	379	8⅓	223	13	330	70	32	78	35
3	80	28¼	718	8⅓	211	3⅛	94	30¾	781	22¼	565	15⅞	392	9⅞	233	13½	343	68	31	81	37
4	100	35¾	908	8⅛	221	4⅓	122	39	991	30¼	768	18	457	11⅛	297	15	381	133	60	156	71
6	150	40¾	1035	10	254	6	152	47⅞	1205	37½	953	20⅛	525	14⅞	360	19½	495	225	102	265	120
8	200	47¾	1213	12⅓	310	6⅞	173	56	1422	45⅞	1146	24⅞	613	16¾	425	21½	546	359	163	435	197

Noryl® is a registered trademark of SABIC Innovative Plastics™

Approvals

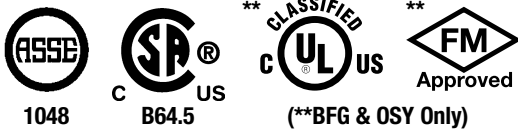

For additional approval information please contact the factory or visit our website at www.amesfirewater.com

Flow capacity chart identifies valve performance based upon rated water velocity up to 25fps

- Service Flow is typically determined by a rated velocity of 7.5fps based upon schedule 40 pipe.
- Rated Flow identifies maximum continuous duty performance determined by AWWA.
- UL Flow Rate is 150% of Rated Flow and is not recommended for continuous duty.
- AWWA Manual M22 [Appendix C] recommends that the maximum water velocity in services be not more than 10fps.

Capacity

UL/FM Certified Flow Characteristics

Flow characteristics collected using butterfly shutoff valves. See literature S-MAXIM-200/300 for gate valve flow characteristics

— Horizontal — Vertical - - - - N-Pattern

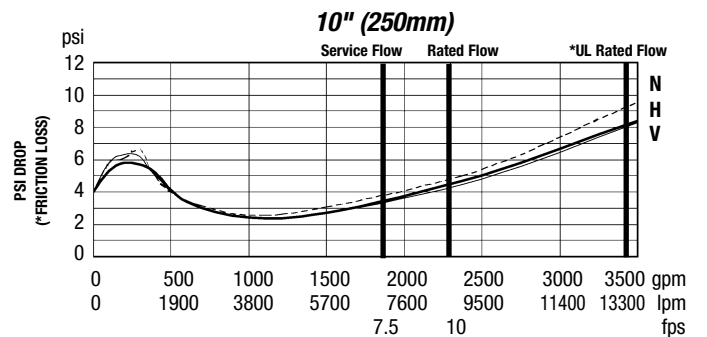
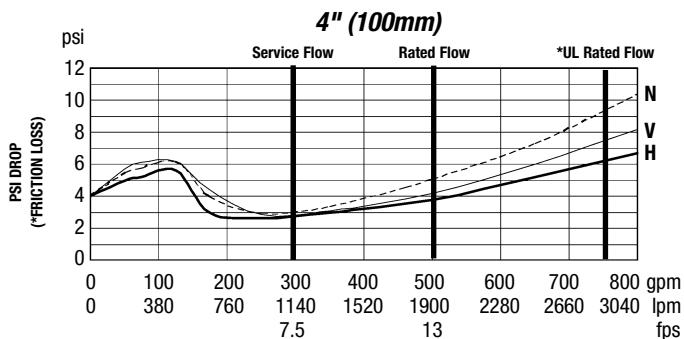
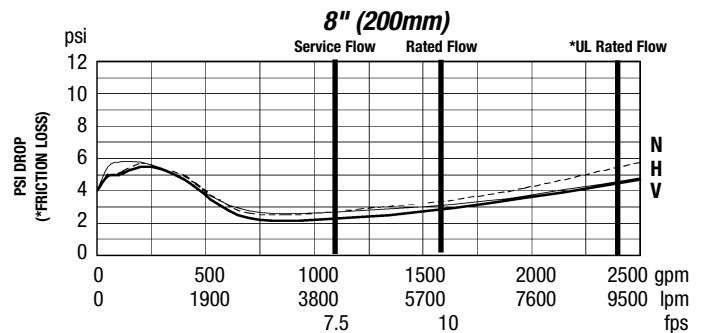
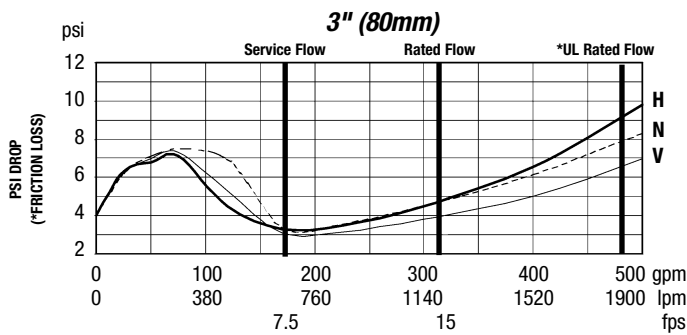
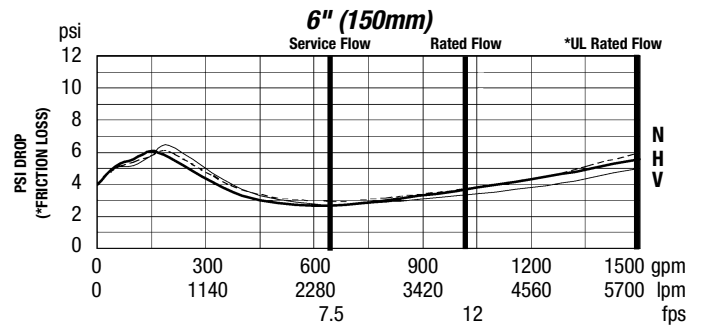
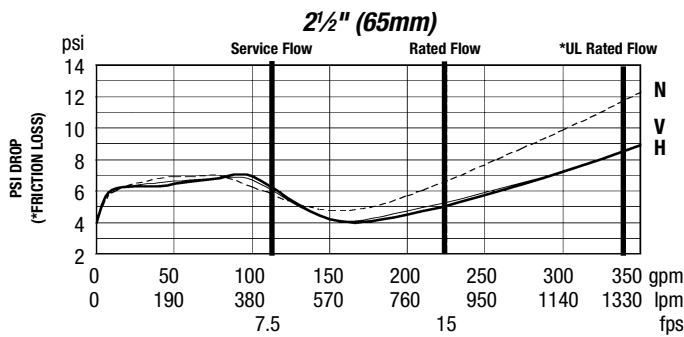

NOTICE

Inquire with governing authorities for local installation requirements



A Watts Water Technologies Company

USA: Backflow Tel: (978) 689-6066 • Fax: (978) 975-8350 • AmesFireWater.com
USA: Control Valves Tel: (713) 943-0688 • Fax: (713) 944-9445 • AmesFireWater.com
Canada: Tel: (905) 332-4090 • Fax: (905) 332-7068 • AmesFireWater.ca
Latin America: Tel: (52) 81-1001-8600 • Fax: (52) 81-8000-7091 • AmesFireWater.com