

Model F-1 Easy Riser® System

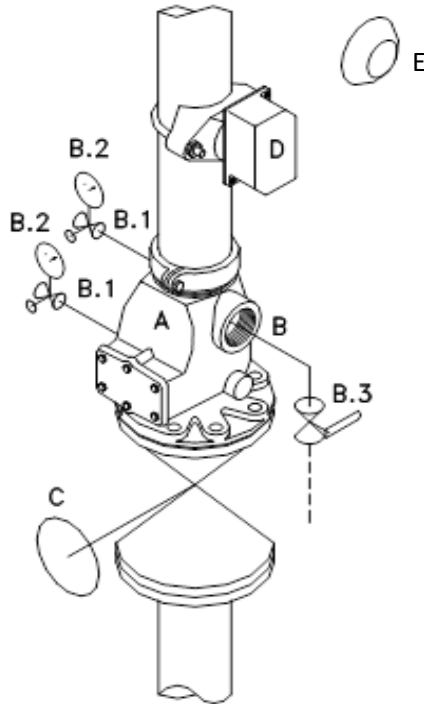



Description
A - Model F-1 Easy Riser® Swing Check Valve
B - Model F-1 Easy Riser® Trim Including:
B.1 - Side Outlet Globe Valve for Gauges
B.2 - Water Gauge
B.3 - Ball Valve
C - Water Supply Control Valve
D - Waterflow Indicator
E - Electric Alarm Bell

* Trims include indented items immediately following.

UL Listed and FM Approved with 300 PSI (20.7 bar) maximum working pressure

Flange / Flange (Model F-1) - Easy Riser® Swing Check Valve						
Size	Valve (only)		Loose Trim (galvanized)		Valve/Trim (pre-trimmed)	
IPG	V220		V222		V221	
3"	08505	\$1,567.34	07236	\$799.33	08505PT	\$2,917.49
4"	08508	\$1,614.94	07237	\$844.96	08508PT	\$3,010.60
6"	08511	\$2,662.74	07237	\$844.96	08511PT	\$4,074.63
Flange / Groove (Model F-1) - Easy Riser® Swing Check Valve						
Size	Valve (only)		Loose Trim (galvanized)		Valve/Trim (pre-trimmed)	
IPG	V220		V222		V221	
3"	08506	\$1,329.27	07236	\$799.33	08506PT	\$2,675.74
4"	08509	\$1,368.22	07237	\$844.96	08509PT	\$2,760.04
6"	08512	\$2,264.37	07237	\$844.96	08512PT	\$3,670.08
8"	08515	\$3,205.01	07237	\$844.96	08515PT	\$5,710.12
Groove / Groove (Model E-1 / F-1) - Easy Riser® Swing Check Valve						
Size	Valve (only)		Loose Trim (galvanized)		Valve/Trim (pre-trimmed)	
IPG	V220		V222		V221	
2-1/2"	07929	\$1,130.04	07236	\$799.33	07929PT	\$2,473.43
3"	08507	\$1,130.04	07236	\$799.33	08507PT	\$2,473.43
4"	08510	\$1,130.04	07237	\$844.96	08510PT	\$2,518.18
6"	08513	\$2,091.24	07237	\$844.96	08513PT	\$3,494.27
8"	08516	\$2,961.50	07237	\$844.96	08516PT	\$5,380.47

* See page L-3 for special valve and trim options, including domestic, brass, and horizontal trim offerings.

Selected Additional Valves and Components (See pages L-4 and L-5 for complete listing)					
In-Line Check Valves (Threaded)		Model M-2 Swing Check Valve		Automatic Ball Drip (Model B-1)	
					
Model K-1 (threaded) 1½" 10659 \$943.43 2" 10667 \$1,090.78 Model L-1 (grooved) 1½" 11054 \$943.43 2" 11059 \$1,090.78 IPG V259		SPRING LOADED 4" / DN100 IPG V220 22550 \$555.03		½" / DN15 IPG V226 04292B \$79.96	
		In-Line Check Valve Trim (1-1/2 & 2")			
		Model K-1 /L-1 IPG V222 1½" and 2" 12960 \$319.07			

Model J-1 Alarm Check Valve

Now cULus Listed and FM Approved with 300 PSI (20.7 bar) maximum working pressure

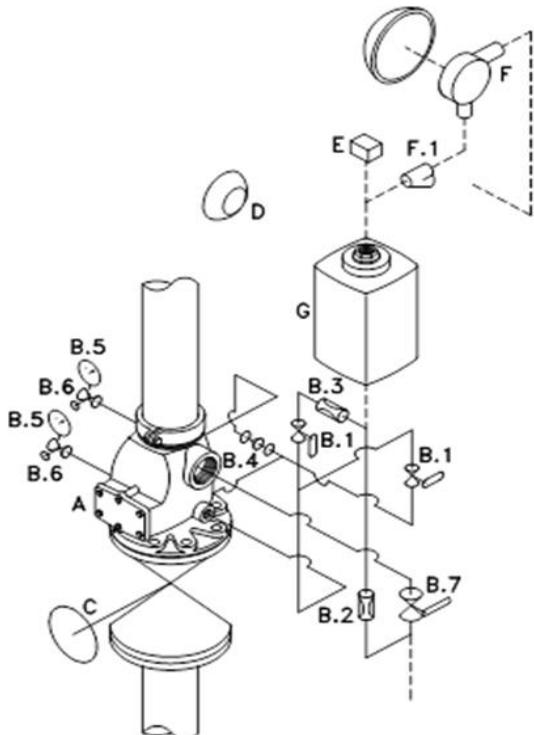

Description

- A Model J-1 Alarm Check Valve
- B Model J-1 Alarm Valve Trim including:
 - B.1 Alarm Test and Shut-Off Valves
 - B.2 1/8" / 3mm Restricted Orifice
 - B.3 7/32" / 5mm Restricted Orifice
 - B.4 3/4" / DN20 Check Valve
 - B.5 Water Gauge
 - B.6 Side Outlet Globe Valve for Gauges
 - B.7 Ball Valve
- C Water Supply Control Valve
- D Electric Alarm Bell
- E Alarm Pressure Switch
- F Model F-2 Water Motor Alarm including:
 - F.1 3/4" / DN20 Alarm Line Y Strainer
- G Model C-1 Retarding Chamber (NOT INCLUDED IN TRIM)
- H Circuit Closer Vent Trim (Not Shown)

* Trims include indented items immediately following.

Flange / Flange (Model J-1) - Alarm Check Valve

Size	Valve (only)		Loose Trim (galvanized)		Valve/Trim (pre-trimmed)	
IPG	V223		V225		V224	
3"	08235	\$2,624.12	08633	\$1,571.10	08235PT	\$4,716.66
4"	08238	\$2,624.12	08634	\$1,666.03	08238PT	\$4,811.55
6"	08241	\$3,280.18	08635	\$1,666.03	08241PT	\$5,467.64
8"	08244	\$4,536.14	08636	\$1,666.03	08244PT	\$6,723.61

Flange / Groove (Model J-1) - Alarm Check Valve

Size	Valve (only)		Loose Trim (galvanized)		Valve/Trim (pre-trimmed)	
IPG	V223		V225		V224	
3"	08236	\$2,624.12	08633	\$1,571.10	08236PT	\$4,716.66
4"	08239	\$2,624.12	08634	\$1,666.03	08239PT	\$4,811.55
6"	08242	\$3,280.18	08635	\$1,666.03	08242PT	\$5,467.64
8"	08245	\$4,536.14	08636	\$1,666.03	08245PT	\$6,723.61

Groove / Groove (Model J-1) - Alarm Check Valve

Size	Valve (only)		Loose Trim (galvanized)		Valve/Trim (pre-trimmed)	
IPG	V223		V225		V224	
3"	08237	\$2,477.41	08633	\$1,571.10	08237PT	\$4,569.95
4"	08240	\$2,477.41	08634	\$1,666.03	08240PT	\$4,664.89
6"	08243	\$2,930.53	08635	\$1,666.03	08243PT	\$5,118.02
8"	08246	\$4,044.11	08636	\$1,666.03	08246PT	\$6,231.58

* See page L-3 for special valve and trim options, including domestic, brass, and horizontal trim offerings.

Selected Additional Valves and Components (See pages L-4 and L-5 for complete listing)

Model C-1 Retard Chamber (not in trim)		EPP Alarm Valve Trim		IPG V227	Circuit Closer Vent Trim		IPG V227
	Model C-1 05904B	IPG V226 \$1,037.39	(for use with excess pressure pump)			01973A Domestic	\$209.48
	Model F-2 07862	IPG V226 \$873.25	3" (DN80)	10854		01973AUSA	\$279.32
			4" (DN100)	10855			
			6" (DN150)	10856			
			8" (DN200)	10857			

Special Valves and Trim

DOMESTIC¹ TRIM (Vertical/Galvanized) - Model J-1 Alarm Check Valve

Size	Trim (loose)
IPG	V225
3"	08633USA \$2,094.81
4"	08634USA \$2,222.71
6"	08635USA \$2,222.71
8"	08636USA \$2,222.71

(1) Meets sourcing requirements of the Buy American Act, American Reinvestment and Recovery Act, and the Buy American Law. Contact customer service for availability.

BRASS TRIM - Model E-1/F-1 Easy Riser® System

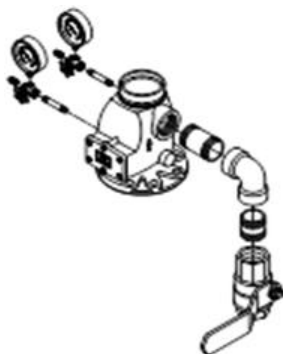

*2-1/2 - 6 inch trim shown

Size	Trim (loose)
IPG	V222
Model K-1/L-1 In-line Check Valve	
1-1/2"	12960-1 \$539.49
2"	12960-1 \$539.49
Model E-1/F-1 Easy Riser® Valve	
2-1/2"	07236-1 \$1,351.35
3"	07236-1 \$1,351.35
4"	07237-1 \$1,428.48
6"	07237-1 \$1,428.48
8"	07237-1 \$1,428.48

BRASS TRIM (Vertical) - Model J-1 Alarm Check Valve

Size	Trim (loose)
IPG	V227
3"	11428 \$2,775.39
4"	11429 \$3,238.64
6"	11430 \$3,398.54
8"	11431 \$3,398.54

*Retard chamber not included in trim (order separately - see page L-4)

BRASS TRIM (Horizontal) - Model J-1 Alarm Check Valve

Size	Trim (loose)
IPG	V227
3"	11432 \$2,873.78
4"	11433 \$3,402.65
6"	11434 \$3,472.38
8"	11435 \$3,472.38

*Retard chamber not included in trim (order separately - see page L-4)

GALVANIZED TRIM (Horizontal) - Model J-1 Alarm Check Valve

Size	Trim (loose)
IPG	V227
3"	08763 \$1,707.07
4"	08765 \$1,751.17
6"	08767 \$1,837.87
8"	08769 \$1,837.87

*Retard chamber not included in trim (order separately - see page L-4)





Additional Valves, Trim, and Components

Model D-1 / G-1 Swing Check Valve



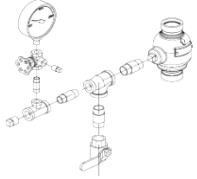
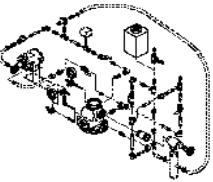

Now cULus Listed
and FM Approved
with 300 PSI (20.7
bar) maximum
working pressure



Size	Flange / Flange		Groove / Groove	
IPG	V220		V220	
2-1/2"			05497C	\$792.35
3"			08536	\$792.37
4"	08538	\$1,818.43	08539	\$792.37
6"	08542	\$2,974.49	08543	\$1,892.07
8"	08546	\$2,884.53	08547	\$2,665.36



<p>In-Line Check Valves (Threaded)</p>  <p><u>Model K-1 (threaded)</u> 1 1/2" 10659 \$943.43 2" 10667 \$1,090.78</p> <p><u>Model L-1 (grooved)</u> 1 1/2" 11054 \$943.43 2" 11059 \$1,090.78 IPG V259</p>	<p>Model M-2 Swing Check Valve</p>  <p>4" / DN100 IPG V220 22550 \$555.03 SPRING LOADED</p>	<p>Automatic Ball Drip (Model B-1)</p>  <p>1/2" / DN15 IPG V226 04292B \$79.96</p>
<p>In-Line Check Valve Trim (1-1/2" - 2")</p>  <p><u>Model L-1 / K-1</u> 12960 \$319.07 IPG V222</p>	<p>Circuit Closer Vent Trim IPG V227</p> <p><u>Standard</u> 01973A \$209.48</p> <p><u>Domestic</u> 01973AUSA \$189.95</p>	<p>EPP Alarm Valve Trim IPG V227</p>  <p>(for use with excess pressure pump)</p> <p>3" (DN80) 10854 \$1,765.36 4" (DN100) 10855 \$1,994.34 6" (DN150) 10856 \$1,994.34 8" (DN200) 10857 \$1,994.34</p>
	<p>Model C-1 Retard Chamber (not in trim)</p>  <p><u>Model C-1</u> IPG V226 05904B \$1,037.39</p>	

Accessories (Included in Alarm Valve Trim) - IPG V226

<p>Water Gauge</p>  <p>0-300 psi 1/4" VWATERSF \$29.92 IPG SR295</p>	<p>Alarm Test/Alarm Shut-Off Valve</p> <p>Main Drain Valve (ball valve)</p>  <p>size part no. list price 1/2" 10355USA \$46.60 1" 10356 \$106.25</p>	<p>Restricted Orifice</p>  <p>1/8" / 3mm Restricted Orifice 1/2" / DN15 06555A \$45.22</p> <p>7/32" / 5mm Restricted Orifice 1/2" / DN15 06980A \$28.70</p> <p>3/8" / 9.5mm Restricted Orifice 3/4" / DN20 10912 \$40.11</p> <p>7/16" / 11.1mm Restricted Orifice 3/4" CCC 12831 \$72.55</p>
<p>Globe Valve for Gauges</p>  <p><u>Side Outlet</u> 1/4" 76V-25 \$25.26 IPG SR140</p>		
<p>In-line Check Valve</p>  <p>3/4" T480-75 \$76.04 1" T480-0100 \$91.20 IPG SR140</p>		

Alarm Devices

Alarm Pressure Switch - SR020

<u>Adjustable Range (4-20 psi)</u>			<u>Explosion Proof</u>		
1/2" / DN50			Dual SPDT	PS10-EX	\$1,894.79
Single SPDT	PS101A	\$269.05	Dual SPDT	PS40EX	\$1,894.79
Dual SPDT	PS102A	\$324.36			<i>* Cenelec approved</i>
	<i>* Manufactured by Potter</i>			<u>Pressure Adj Access Key</u>	
				10600	\$38.42
				<u>Cover Removal Key</u>	
				10601	\$38.42

** Appropriate hex keys included with switches.*

Pressure Supervisory Switch - IPG SR020



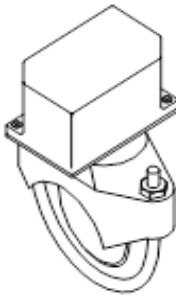

<u>Explosion Proof</u>		
Dual SPDT	10379	\$2,531.67
		<i>* Cenelec approved</i>
	<u>Pressure Adj Access Key</u>	
	10600	\$38.42
	<u>Cover Removal Key</u>	
	10601	\$38.42

** Appropriate hex keys included with switches.*

Flow Switch - SR010

<u>Waterflow Indicators</u>			
<i>(adjustable retard up to 120 sec. - 2 SPDT contacts)</i>			
<u>Model VSR</u>			
1-2" / DN40	VSRF0100	\$390.46	
2" / DN50	VSRF0200	\$422.48	
2½" / DN65	VSRF0250	\$422.48	
3" / DN80	VSRF0300	\$422.48	
3½" / DN90	VSRF0350	\$422.48	
4" / DN100	VSRF0400	\$422.48	
5" / DN125	VSRF0500	\$422.48	
6" / DN150	VSRF0600	\$422.48	
8" / DN200	VSRF0800	\$473.72	

Water Motor Alarm and Accessories - IPG V226

<u>Water Motor Alarm</u>		<u>Closure Plate</u>	
	<u>Model F-2</u>		
	07862	05820B	\$178.23
<u>Adjustable Shaft</u>		<u>Alarm Line Y Strainer</u>	
<i>(wall thickness up to 30-1/4 in / 768 mm)</i>			<u>3/4" (DN20)</u>
	03312B	01489A	\$260.03
<u>Extension Cup</u>			
	05957B	\$142.59	

EasyPac™ Residential Riser Assemblies		
Basic (w/ ball valve)	TESTanDRAIN®	TESTanDRAIN® & PRV
Features and Benefits of all EasyPac™ Riser Assemblies <ul style="list-style-type: none"> - Assembled in the United States. - Made with UL listed and FM approved components. - Field replaceable parts for ease of service. - Fabricated steel riser body with black powder coat finish. - Compact, lightweight design for easy installation. - Built-in test port allows hydrostatic testing w/out draining system. - Pressure rating: 250 PSI max water working pressure. - Includes Potter® VSR flow switch. 		

RESIDENTIAL - Basic (with ball valve)			
Size	Part #	IPG	List Price
Groove x Groove (schedule 10)			
1"	15243	V263	\$1,259.83
1-1/4"	14841	V263	\$1,207.37
1-1/2"	14843	V263	\$1,289.11
2"	14845	V263	\$1,313.07
Thread x Groove (schedule 40)			
1-1/4"	14905	V263	\$1,236.79
1-1/2"	14849	V263	\$1,299.51
2"	14846	V263	\$1,322.18
Thread x Thread (schedule 40)			
1"	15226	V263	\$1,208.65
1-1/4"	14840	V263	\$1,209.13
1-1/2"	14842	V263	\$1,292.33
2"	14844	V263	\$1,317.58

RESIDENTIAL (with TESTanDRAIN®)									
Size	Orifice Size	Part #	IPG	List Price	Size	Orifice Size	Part #	IPG	List Price
Groove x Groove (schedule 10)					Thread x Groove (schedule 40)				
1"	3/8" (2.8 K)	15244A	V263	\$1,996.74	1-1/4"	3/8" (2.8 K)	15233A	V263	\$2,065.86
1"	7/16" (4.2 K)	15244B	V263	\$1,996.74	1-1/4"	7/16" (4.2 K)	15233B	V263	\$2,065.86
1"	1/2" (5.6 K)	15244C	V263	\$1,996.74	1-1/4"	1/2" (5.6 K)	15233C	V263	\$2,065.86
1"	17/32" (8.0 K)	15244D	V263	\$1,996.74	1-1/4"	17/32" (8.0 K)	15233D	V263	\$2,065.86
1-1/4"	3/8" (2.8 K)	15231A	V263	\$2,035.83	1-1/2"	3/8" (2.8 K)	15239A	V263	\$2,049.13
1-1/4"	7/16" (4.2 K)	15231B	V263	\$2,035.83	1-1/2"	7/16" (4.2 K)	15239B	V263	\$2,049.13
1-1/4"	1/2" (5.6 K)	15231C	V263	\$2,035.83	1-1/2"	1/2" (5.6 K)	15239C	V263	\$2,049.13
1-1/4"	17/32" (8.0 K)	15231D	V263	\$2,035.83	1-1/2"	17/32" (8.0 K)	15239D	V263	\$2,049.13
1-1/2"	3/8" (2.8 K)	15237A	V263	\$2,038.74	2"	3/8" (2.8 K)	15246A	V263	\$1,867.04
1-1/2"	7/16" (4.2 K)	15237B	V263	\$2,038.74	2"	7/16" (4.2 K)	15246B	V263	\$1,867.04
1-1/2"	1/2" (5.6 K)	15237C	V263	\$2,038.74	2"	1/2" (5.6 K)	15246C	V263	\$1,867.04
1-1/2"	17/32" (8.0 K)	15237D	V263	\$2,038.74	2"	17/32" (8.0 K)	15246D	V263	\$1,867.04
2"	3/8" (2.8 K)	15242A	V263	\$1,854.84					
2"	7/16" (4.2 K)	15242B	V263	\$1,854.84					
2"	1/2" (5.6 K)	15242C	V263	\$1,854.84					
2"	17/32" (8.0 K)	15242D	V263	\$1,854.84					
Thread x Thread (schedule 40)									
1"	3/8" (2.8 K)	15227A	V263	\$1,946.12					
1"	7/16" (4.2 K)	15227B	V263	\$1,946.12					
1"	1/2" (5.6 K)	15227C	V263	\$1,946.12					
1"	17/32" (8.0 K)	15227D	V263	\$1,946.12					
1-1/4"	3/8" (2.8 K)	15229A	V263	\$2,037.57					
1-1/4"	7/16" (4.2 K)	15229B	V263	\$2,037.57					
1-1/4"	1/2" (5.6 K)	15229C	V263	\$2,037.57					
1-1/4"	17/32" (8.0 K)	15229D	V263	\$2,037.57					
1-1/2"	3/8" (2.8 K)	15235A	V263	\$2,041.98					
1-1/2"	7/16" (4.2 K)	15235B	V263	\$2,041.98					
1-1/2"	1/2" (5.6 K)	15235C	V263	\$2,041.98					
1-1/2"	17/32" (8.0 K)	15235D	V263	\$2,041.98					
2"	3/8" (2.8 K)	15241A	V263	\$1,859.33					
2"	7/16" (4.2 K)	15241B	V263	\$1,859.33					
2"	1/2" (5.6 K)	15241C	V263	\$1,859.33					
2"	17/32" (8.0 K)	15241D	V263	\$1,859.33					

TESTanDRAIN® is a registered trademark of AGF Manufacturing, Inc.

RESIDENTIAL (with TESTanDRAIN® and PRV)											
Size	Orifice Size	PRV ¹	Part #	IPG	List Price	Size	Orifice Size	PRV ¹	Part #	IPG	List Price
Groove x Groove (schedule 10)						Thread x Groove (schedule 10)					
1"	3/8" (2.8 K)	175	15245A175	V263	\$2,223.24	N/A					
1"	3/8" (2.8 K)	205	15245A200	V263	\$2,223.24						
1"	3/8" (2.8 K)	250	15245A300	V263	\$2,223.24						
1"	7/16" (4.2 K)	175	15245B175	V263	\$2,223.24						
1"	7/16" (4.2 K)	205	15245B200	V263	\$2,223.24						
1"	7/16" (4.2 K)	250	15245B300	V263	\$2,223.24						
1"	1/2" (5.6 K)	175	15245C175	V263	\$2,223.24						
1"	1/2" (5.6 K)	205	15245C200	V263	\$2,223.24						
1"	1/2" (5.6 K)	250	15245C300	V263	\$2,223.24						
1"	17/32" (8.0 K)	175	15245D175	V263	\$2,223.24						
1"	17/32" (8.0 K)	205	15245D200	V263	\$2,223.24						
1"	17/32" (8.0 K)	250	15245D300	V263	\$2,223.24						
1-1/4"	3/8" (2.8 K)	175	15232A175	V263	\$2,261.77						
1-1/4"	3/8" (2.8 K)	205	15232A200	V263	\$2,261.77						
1-1/4"	3/8" (2.8 K)	250	15232A300	V263	\$2,261.77						
1-1/4"	7/16" (4.2 K)	175	15232B175	V263	\$2,261.77						
1-1/4"	7/16" (4.2 K)	205	15232B200	V263	\$2,261.77						
1-1/4"	7/16" (4.2 K)	250	15232B300	V263	\$2,261.77						
1-1/4"	1/2" (5.6 K)	175	15232C175	V263	\$2,261.77						
1-1/4"	1/2" (5.6 K)	205	15232C200	V263	\$2,261.77						
1-1/4"	1/2" (5.6 K)	250	15232C300	V263	\$2,261.77						
1-1/4"	17/32" (8.0 K)	175	15232D175	V263	\$2,261.77						
1-1/4"	17/32" (8.0 K)	205	15232D200	V263	\$2,261.77						
1-1/4"	17/32" (8.0 K)	250	15232D300	V263	\$2,261.77						
1-1/2"	3/8" (2.8 K)	175	15238A175	V263	\$2,264.68						
1-1/2"	3/8" (2.8 K)	205	15238A200	V263	\$2,264.68						
1-1/2"	3/8" (2.8 K)	250	15238A300	V263	\$2,264.68						
1-1/2"	7/16" (4.2 K)	175	15238B175	V263	\$2,264.68						
1-1/2"	7/16" (4.2 K)	205	15238B200	V263	\$2,264.68						
1-1/2"	7/16" (4.2 K)	250	15238B300	V263	\$2,264.68						
1-1/2"	1/2" (5.6 K)	175	15238C175	V263	\$2,264.68						
1-1/2"	1/2" (5.6 K)	205	15238C200	V263	\$2,264.68						
1-1/2"	1/2" (5.6 K)	250	15238C300	V263	\$2,264.68						
1-1/2"	17/32" (8.0 K)	175	15238D175	V263	\$2,264.68						
1-1/2"	17/32" (8.0 K)	205	15238D200	V263	\$2,264.68						
1-1/2"	17/32" (8.0 K)	250	15238D300	V263	\$2,264.68						
2"	3/8" (2.8 K)	175	14900A175	V263	\$2,314.51						
2"	3/8" (2.8 K)	205	14900A200	V263	\$2,314.51						
2"	3/8" (2.8 K)	250	14900A300	V263	\$2,314.51						
2"	7/16" (4.2 K)	175	14900B175	V263	\$2,314.51						
2"	7/16" (4.2 K)	205	14900B200	V263	\$2,314.51						
2"	7/16" (4.2 K)	250	14900B300	V263	\$2,314.51						
2"	1/2" (5.6 K)	175	14900C175	V263	\$2,314.51						
2"	1/2" (5.6 K)	205	14900C200	V263	\$2,314.51						
2"	1/2" (5.6 K)	250	14900C300	V263	\$2,314.51						
2"	17/32" (8.0 K)	175	14900D175	V263	\$2,314.51						
2"	17/32" (8.0 K)	205	14900D200	V263	\$2,314.51						
2"	17/32" (8.0 K)	250	14900D300	V263	\$2,314.51						
2"	3/8" (2.8 K)	175	15247A175	V263	\$2,096.43						
2"	3/8" (2.8 K)	205	15247A200	V263	\$2,096.43						
2"	3/8" (2.8 K)	250	15247A300	V263	\$2,096.43						
2"	7/16" (4.2 K)	175	15247B175	V263	\$2,096.43						
2"	7/16" (4.2 K)	205	15247B200	V263	\$2,096.43						
2"	7/16" (4.2 K)	250	15247B300	V263	\$2,096.43						
2"	1/2" (5.6 K)	175	15247C175	V263	\$2,096.43						
2"	1/2" (5.6 K)	205	15247C200	V263	\$2,096.43						
2"	1/2" (5.6 K)	250	15247C300	V263	\$2,096.43						
2"	17/32" (8.0 K)	175	15247D175	V263	\$2,096.43						
2"	17/32" (8.0 K)	205	15247D200	V263	\$2,096.43						
2"	17/32" (8.0 K)	250	15247D300	V263	\$2,096.43						

(1) Refers to factory pressure setting (psi) of pressure relief valve (PRV).

TESTanDRAIN® is a registered trademark of AGF Manufacturing, Inc.

Residential (with TESTanDRAIN® and PRV)					
Size	Orifice Size	PRV ¹	Part #	IPG	List Price
Thread x Thread (schedule 40)					
1"	3/8" (2.8 K)	175	15228A175	V263	\$2,172.04
1"	3/8" (2.8 K)	205	15228A200	V263	\$2,172.04
1"	3/8" (2.8 K)	250	15228A300	V263	\$2,172.04
1"	7/16" (4.2 K)	175	15228B175	V263	\$2,172.04
1"	7/16" (4.2 K)	205	15228B200	V263	\$2,172.04
1"	7/16" (4.2 K)	250	15228B300	V263	\$2,172.04
1"	1/2" (5.6 K)	175	15228C175	V263	\$2,172.04
1"	1/2" (5.6 K)	205	15228C200	V263	\$2,172.04
1"	1/2" (5.6 K)	250	15228C300	V263	\$2,172.04
1"	17/32" (8.0 K)	175	15228D175	V263	\$2,172.04
1"	17/32" (8.0 K)	205	15228D200	V263	\$2,172.04
1"	17/32" (8.0 K)	250	15228D300	V263	\$2,172.04
1-1/4"	3/8" (2.8 K)	175	15230A175	V263	\$2,263.50
1-1/4"	3/8" (2.8 K)	205	15230A200	V263	\$2,263.50
1-1/4"	3/8" (2.8 K)	250	15230A300	V263	\$2,263.50
1-1/4"	7/16" (4.2 K)	175	15230B175	V263	\$2,263.50
1-1/4"	7/16" (4.2 K)	205	15230B200	V263	\$2,263.50
1-1/4"	7/16" (4.2 K)	250	15230B300	V263	\$2,263.50
1-1/4"	1/2" (5.6 K)	175	15230C175	V263	\$2,263.50
1-1/4"	1/2" (5.6 K)	205	15230C200	V263	\$2,263.50
1-1/4"	1/2" (5.6 K)	250	15230C300	V263	\$2,263.50
1-1/4"	17/32" (8.0 K)	175	15230D175	V263	\$2,263.50
1-1/4"	17/32" (8.0 K)	205	15230D200	V263	\$2,263.50
1-1/4"	17/32" (8.0 K)	250	15230D300	V263	\$2,263.50
1-1/2"	3/8" (2.8 K)	175	15236A175	V263	\$2,267.89
1-1/2"	3/8" (2.8 K)	205	15236A200	V263	\$2,267.89
1-1/2"	3/8" (2.8 K)	250	15236A300	V263	\$2,267.89
1-1/2"	7/16" (4.2 K)	175	15236B175	V263	\$2,267.89
1-1/2"	7/16" (4.2 K)	205	15236B200	V263	\$2,267.89
1-1/2"	7/16" (4.2 K)	250	15236B300	V263	\$2,267.89
1-1/2"	1/2" (5.6 K)	175	15236C175	V263	\$2,267.89
1-1/2"	1/2" (5.6 K)	205	15236C200	V263	\$2,267.89
1-1/2"	1/2" (5.6 K)	250	15236C300	V263	\$2,267.89
1-1/2"	17/32" (8.0 K)	175	15236D175	V263	\$2,267.89
1-1/2"	17/32" (8.0 K)	205	15236D200	V263	\$2,267.89
1-1/2"	17/32" (8.0 K)	250	15236D300	V263	\$2,267.89
2"	3/8" (2.8 K)	175	14901A175	V263	\$2,330.00
2"	3/8" (2.8 K)	205	14901A200	V263	\$2,330.00
2"	3/8" (2.8 K)	250	14901A300	V263	\$2,330.00
2"	7/16" (4.2 K)	175	14901B175	V263	\$2,330.00
2"	7/16" (4.2 K)	205	14901B200	V263	\$2,330.00
2"	7/16" (4.2 K)	250	14901B300	V263	\$2,330.00
2"	1/2" (5.6 K)	175	14901C175	V263	\$2,330.00
2"	1/2" (5.6 K)	205	14901C200	V263	\$2,330.00
2"	1/2" (5.6 K)	250	14901C300	V263	\$2,330.00
2"	17/32" (8.0 K)	175	14901D175	V263	\$2,330.00
2"	17/32" (8.0 K)	205	14901D200	V263	\$2,330.00
2"	17/32" (8.0 K)	250	14901D300	V263	\$2,330.00

(1) Refers to factory pressure setting (psi) of pressure relief valve (PRV).

TESTanDRAIN® is a registered trademark of AGF Manufacturing, Inc.

EasyPac™ COMMERCIAL Riser Assemblies		
Basic (w/ ball valve)	TESTanDRAIN®	TESTanDRAIN® & PRV
Features and Benefits of all EasyPac™ Riser Assemblies <ul style="list-style-type: none"> - Assembled in the United States. - Made with UL listed and FM approved components. - Field replaceable parts for ease of service. - Fabricated steel riser body with black powder coat finish. - Compact, lightweight design for easy installation. - Built-in test port allows hydrostatic testing w/out draining system. - Pressure rating: 250 PSI max water working pressure. - Includes Potter® VSR flow switch. 		

COMMERCIAL -Basic (with ball valve)			
Size	Part #	IPG	List Price
Groove x Groove (schedule 10)			
1-1/4"	15249	V261	\$1,850.98
1-1/2"	15254	V261	\$1,368.22
2"	14848	V261	\$1,222.53
2-1/2"	14852	V261	\$1,257.68
3"	14855	V261	\$1,411.38
4"	14858	V261	\$1,648.42
6"	14861	V261	\$1,843.10
8"	15264	V261	\$2,598.10
Thread x Groove (schedule 40)			
1-1/4"	15250	V261	\$1,888.45
1-1/2"	15255	V261	\$1,379.21
2"	15258	V261	\$1,478.10
Thread x Thread (schedule 40)			
1-1/4"	15248	V261	\$1,853.15
1-1/2"	15253	V261	\$1,371.63
2"	14899	V261	\$1,261.37

COMMERCIAL (with TESTanDRAIN®)									
Size	Orifice Size	Part #	IPG	List Price	Size	Orifice Size	Part #	IPG	List Price
Groove x Groove (schedule 10)					Groove x Groove (schedule 10)				
1-1/4"	3/8" (2.8 K)	14872A	V261	\$2,160.72	3"	3/8" (2.8 K)	14856A	V261	\$2,318.90
1-1/4"	7/16" (4.2 K)	14872B	V261	\$2,160.72	3"	7/16" (4.2 K)	14856B	V261	\$2,318.90
1-1/4"	1/2" (5.6 K)	14872C	V261	\$2,160.72	3"	1/2" (5.6 K)	14856C	V261	\$2,318.90
1-1/4"	17/32" (8.0 K)	14872D	V261	\$2,160.72	3"	17/32" (8.0 K)	14856D	V261	\$2,318.90
1-1/4"	ELO (11.2 K)	14872E	V261	\$2,160.72	3"	ELO (11.2 K)	14856E	V261	\$2,318.90
					3"	ESFR (14.0 K)	14856F	V261	\$2,318.90
					3"	ESFR (25.2 K)	14856G	V261	P.O.A.
1-1/2"	3/8" (2.8 K)	14876A	V261	\$2,163.82	4"	3/8" (2.8 K)	14859A	V261	\$3,052.76
1-1/2"	7/16" (4.2 K)	14876B	V261	\$2,163.82	4"	7/16" (4.2 K)	14859B	V261	\$3,052.76
1-1/2"	1/2" (5.6 K)	14876C	V261	\$2,163.82	4"	1/2" (5.6 K)	14859C	V261	\$3,052.76
1-1/2"	17/32" (8.0 K)	14876D	V261	\$2,163.82	4"	17/32" (8.0 K)	14859D	V261	\$3,052.76
1-1/2"	ELO (11.2 K)	14876E	V261	\$2,163.82	4"	ELO (11.2 K)	14859E	V261	\$3,052.76
					4"	ESFR (14.0 K)	14859F	V261	\$3,052.76
					4"	ESFR (25.2 K)	14859G	V261	\$3,175.69
2"	3/8" (2.8 K)	14850A	V261	\$2,125.72	6"	3/8" (2.8 K)	14862A	V261	\$3,302.81
2"	7/16" (4.2 K)	14850B	V261	\$2,125.72	6"	7/16" (4.2 K)	14862B	V261	\$3,302.81
2"	1/2" (5.6 K)	14850C	V261	\$2,125.72	6"	1/2" (5.6 K)	14862C	V261	\$3,302.81
2"	17/32" (8.0 K)	14850D	V261	\$2,125.72	6"	17/32" (8.0 K)	14862D	V261	\$3,302.81
2"	ELO (11.2 K)	14850E	V261	\$2,125.72	6"	ELO (11.2 K)	14862E	V261	\$3,302.81
					6"	ESFR (14.0 K)	14862F	V261	\$3,302.81
					6"	ESFR (25.2 K)	14862G	V261	\$3,339.97
2-1/2"	3/8" (2.8 K)	14853A	V261	\$2,165.19	8"	3/8" (2.8 K)	15265A	V261	\$4,469.65
2-1/2"	7/16" (4.2 K)	14853B	V261	\$2,165.19	8"	7/16" (4.2 K)	15265B	V261	\$4,469.65
2-1/2"	1/2" (5.6 K)	14853C	V261	\$2,165.19	8"	1/2" (5.6 K)	15265C	V261	\$4,469.65
2-1/2"	17/32" (8.0 K)	14853D	V261	\$2,165.19	8"	17/32" (8.0 K)	15265D	V261	\$4,469.65
2-1/2"	ELO (11.2 K)	14853E	V261	\$2,165.19	8"	ELO (11.2 K)	15265E	V261	\$4,469.65
2-1/2"	ESFR (14.0 K)	14853F	V261	\$2,165.19	8"	ESFR (14.0 K)	15265F	V261	\$4,469.65
2-1/2"	ESFR (25.2 K)	14853G	V261	P.O.A.	8"	ESFR (25.2 K)	15265G	V261	\$4,469.65

TESTanDRAIN® is a registered trademark of AGF Manufacturing, Inc.



COMMERCIAL (with TESTanDRAIN®)										
Size	Orifice Size	Part #	IPG	List Price		Size	Orifice Size	Part #	IPG	List Price
Thread x Groove (schedule 40)						Thread x Thread (schedule 40)				
1-1/4"	3/8" (2.8 K)	15251A	V261	\$2,192.62		1-1/4"	3/8" (2.8 K)	14871A	V261	\$2,162.61
1-1/4"	7/16" (4.2 K)	15251B	V261	\$2,192.62		1-1/4"	7/16" (4.2 K)	14871B	V261	\$2,162.61
1-1/4"	1/2" (5.6 K)	15251C	V261	\$2,192.62		1-1/4"	1/2" (5.6 K)	14871C	V261	\$2,162.61
1-1/4"	17/32" (8.0 K)	15251D	V261	\$2,192.62		1-1/4"	17/32" (8.0 K)	14871D	V261	\$2,162.61
1-1/4"	17/32" (8.0 K)	15251E	V261	\$2,192.62		1-1/4"	17/32" (8.0 K)	14871E	V261	\$2,162.61
1-1/2"	3/8" (2.8 K)	15256A	V261	\$2,174.82		1-1/2"	3/8" (2.8 K)	14875A	V261	\$2,167.26
1-1/2"	7/16" (4.2 K)	15256B	V261	\$2,174.82		1-1/2"	7/16" (4.2 K)	14875B	V261	\$2,167.26
1-1/2"	1/2" (5.6 K)	15256C	V261	\$2,174.82		1-1/2"	1/2" (5.6 K)	14875C	V261	\$2,167.26
1-1/2"	17/32" (8.0 K)	15256D	V261	\$2,174.82		1-1/2"	17/32" (8.0 K)	14875D	V261	\$2,167.26
1-1/2"	17/32" (8.0 K)	15256E	V261	\$2,174.82		1-1/2"	17/32" (8.0 K)	14875E	V261	\$2,167.26
2"	3/8" (2.8 K)	15259A	V261	\$2,540.16		2"	3/8" (2.8 K)	14935A	V261	\$2,165.19
2"	7/16" (4.2 K)	15259B	V261	\$2,540.16		2"	7/16" (4.2 K)	14935B	V261	\$2,165.19
2"	1/2" (5.6 K)	15259C	V261	\$2,540.16		2"	1/2" (5.6 K)	14935C	V261	\$2,165.19
2"	17/32" (8.0 K)	15259D	V261	\$2,540.16		2"	17/32" (8.0 K)	14935D	V261	\$2,165.19
2"	ELO (11.2 K)	15259E	V261	\$2,540.16		2"	ELO (11.2 K)	14935E	V261	\$2,165.19

COMMERCIAL (with TESTanDRAIN® and PRV)											
Size	Orifice Size	PRV ¹	Part #	IPG	List Price	Size	Orifice Size	PRV ¹	Part #	IPG	List Price
Groove x Groove (schedule 10)						Groove x Groove (schedule 10)					
1-1/4"	3/8" (2.8 K)	175	14874A175	V261	\$2,400.54	2"	3/8" (2.8 K)	175	14851A175	V261	\$2,369.81
1-1/4"	3/8" (2.8 K)	205	14874A200	V261	\$2,400.54	2"	3/8" (2.8 K)	205	14851A200	V261	\$2,369.81
1-1/4"	3/8" (2.8 K)	250	14874A300	V261	\$2,400.54	2"	3/8" (2.8 K)	250	14851A300	V261	\$2,369.81
1-1/4"	7/16" (4.2 K)	175	14874B175	V261	\$2,400.54	2"	7/16" (4.2 K)	175	14851B175	V261	\$2,369.81
1-1/4"	7/16" (4.2 K)	205	14874B200	V261	\$2,400.54	2"	7/16" (4.2 K)	205	14851B200	V261	\$2,369.81
1-1/4"	7/16" (4.2 K)	250	14874B300	V261	\$2,400.54	2"	7/16" (4.2 K)	250	14851B300	V261	\$2,369.81
1-1/4"	1/2" (5.6 K)	175	14874C175	V261	\$2,400.54	2"	1/2" (5.6 K)	175	14851C175	V261	\$2,369.81
1-1/4"	1/2" (5.6 K)	205	14874C200	V261	\$2,400.54	2"	1/2" (5.6 K)	205	14851C200	V261	\$2,369.81
1-1/4"	1/2" (5.6 K)	250	14874C300	V261	\$2,400.54	2"	1/2" (5.6 K)	250	14851C300	V261	\$2,369.81
1-1/4"	17/32" (8.0 K)	175	14874D175	V261	\$2,400.54	2"	17/32" (8.0 K)	175	14851D175	V261	\$2,369.81
1-1/4"	17/32" (8.0 K)	205	14874D200	V261	\$2,400.54	2"	17/32" (8.0 K)	205	14851D200	V261	\$2,369.81
1-1/4"	17/32" (8.0 K)	250	14874D300	V261	\$2,400.54	2"	17/32" (8.0 K)	250	14851D300	V261	\$2,369.81
1-1/4"	ELO (11.2 K)	175	14874E175	V261	\$2,400.54	2"	ELO (11.2 K)	175	14851E175	V261	\$2,369.81
1-1/4"	ELO (11.2 K)	205	14874A200	V261	\$2,400.54	2"	ELO (11.2 K)	205	14875E200	V261	\$2,369.81
1-1/4"	ELO (11.2 K)	250	14874A300	V261	\$2,400.54	2"	ELO (11.2 K)	250	14851E300	V261	\$2,369.81
1-1/2"	3/8" (2.8 K)	175	14878A175	V261	\$2,403.64	2-1/2"	3/8" (2.8 K)	175	14854A175	V261	\$2,409.32
1-1/2"	3/8" (2.8 K)	205	14878A200	V261	\$2,403.64	2-1/2"	3/8" (2.8 K)	205	14854A200	V261	\$2,409.32
1-1/2"	3/8" (2.8 K)	250	14878A300	V261	\$2,403.64	2-1/2"	3/8" (2.8 K)	250	14854A300	V261	\$2,409.32
1-1/2"	7/16" (4.2 K)	175	14878B175	V261	\$2,403.64	2-1/2"	7/16" (4.2 K)	175	14854B175	V261	\$2,409.32
1-1/2"	7/16" (4.2 K)	205	14878B200	V261	\$2,403.64	2-1/2"	7/16" (4.2 K)	205	14854B200	V261	\$2,409.32
1-1/2"	7/16" (4.2 K)	250	14878B300	V261	\$2,403.64	2-1/2"	7/16" (4.2 K)	250	14854B300	V261	\$2,409.32
1-1/2"	1/2" (5.6 K)	175	14878C175	V261	\$2,403.64	2-1/2"	1/2" (5.6 K)	175	14854C175	V261	\$2,409.32
1-1/2"	1/2" (5.6 K)	205	14878C200	V261	\$2,403.64	2-1/2"	1/2" (5.6 K)	205	14854C200	V261	\$2,409.32
1-1/2"	1/2" (5.6 K)	250	14878C300	V261	\$2,403.64	2-1/2"	1/2" (5.6 K)	250	14854C300	V261	\$2,409.32
1-1/2"	17/32" (8.0 K)	175	14878D175	V261	\$2,403.64	2-1/2"	17/32" (8.0 K)	175	14854D175	V261	\$2,409.32
1-1/2"	17/32" (8.0 K)	205	14878D200	V261	\$2,403.64	2-1/2"	17/32" (8.0 K)	205	14854D200	V261	\$2,409.32
1-1/2"	17/32" (8.0 K)	250	14878D300	V261	\$2,403.64	2-1/2"	17/32" (8.0 K)	250	14854D300	V261	\$2,409.32
1-1/2"	ELO (11.2 K)	175	14878E175	V261	\$2,403.64	2-1/2"	ELO (11.2 K)	175	14854E175	V261	\$2,409.32
1-1/2"	ELO (11.2 K)	205	14878D200	V261	\$2,403.64	2-1/2"	ELO (11.2 K)	205	14854E200	V261	\$2,409.32
1-1/2"	ELO (11.2 K)	250	14878D300	V261	\$2,403.64	2-1/2"	ELO (11.2 K)	250	14875E300	V261	\$2,409.32
						2-1/2"	ESFR (14.0 K)	175	14854F175	V261	\$2,409.32
						2-1/2"	ESFR (14.0 K)	205	14854F200	V261	\$2,409.32
						2-1/2"	ESFR (14.0 K)	250	14854F300	V261	\$2,409.32

(1) Refers to factory pressure setting (psi) of pressure relief valve (PRV).



COMMERCIAL (with TESTanDRAIN® and PRV)											
Size	Orifice Size	PRV ¹	Part #	IPG	List Price	Size	Orifice Size	PRV ¹	Part #	IPG	List Price
Groove x Groove (schedule 10)						Groove x Groove (schedule 10)					
3"	3/8" (2.8 K)	175	14857A175	V261	\$2,562.98	6"	3/8" (2.8 K)	175	14863A175	V261	\$3,542.58
3"	3/8" (2.8 K)	205	14857A200	V261	\$2,562.98	6"	3/8" (2.8 K)	205	14863A200	V261	\$3,542.58
3"	3/8" (2.8 K)	250	14857A300	V261	\$2,562.98	6"	3/8" (2.8 K)	250	14863A300	V261	\$3,542.58
3"	7/16" (4.2 K)	175	14857B175	V261	\$2,562.98	6"	7/16" (4.2 K)	175	14863B175	V261	\$3,542.58
3"	7/16" (4.2 K)	205	14857B200	V261	\$2,562.98	6"	7/16" (4.2 K)	205	14863B200	V261	\$3,542.58
3"	7/16" (4.2 K)	250	14857B300	V261	\$2,562.98	6"	7/16" (4.2 K)	250	14863B300	V261	\$3,542.58
3"	1/2" (5.6 K)	175	14857C175	V261	\$2,562.98	6"	1/2" (5.6 K)	175	14863C175	V261	\$3,542.58
3"	1/2" (5.6 K)	205	14857C200	V261	\$2,562.98	6"	1/2" (5.6 K)	205	14863C200	V261	\$3,542.58
3"	1/2" (5.6 K)	250	14857C300	V261	\$2,562.98	6"	1/2" (5.6 K)	250	14863C300	V261	\$3,542.58
3"	17/32" (8.0 K)	175	14857D175	V261	\$2,562.98	6"	17/32" (8.0 K)	175	14863D175	V261	\$3,542.58
3"	17/32" (8.0 K)	205	14857D200	V261	\$2,562.98	6"	17/32" (8.0 K)	205	14863D200	V261	\$3,542.58
3"	17/32" (8.0 K)	250	14857D300	V261	\$2,562.98	6"	17/32" (8.0 K)	250	14863D300	V261	\$3,542.58
3"	ELO (11.2 K)	175	14857E175	V261	\$2,562.98	6"	ELO (11.2 K)	175	14863E175	V261	\$3,542.58
3"	ELO (11.2 K)	205	14857E200	V261	\$2,562.98	6"	ELO (11.2 K)	205	14863E200	V261	\$3,542.58
3"	ELO (11.2 K)	250	14857E300	V261	\$2,562.98	6"	ELO (11.2 K)	250	14863E300	V261	\$3,542.58
3"	ESFR - 14.0 K	175	14857F175	V261	\$2,562.98	6"	ESFR - 14.0 K	175	14863F175	V261	\$3,542.58
3"	ESFR - 14.0 K	205	14857F200	V261	\$2,562.98	6"	ESFR - 14.0 K	205	14863F200	V261	\$3,542.58
3"	ESFR - 14.0 K	250	14857F300	V261	\$2,562.98	6"	ESFR - 14.0 K	250	14863F300	V261	\$3,542.58
3"	ESFR - 25.2 K	175	14857G175	V261	P.O.A.	6"	ESFR - 25.2 K	175	14863G175	V261	\$3,579.64
3"	ESFR - 25.2 K	205	14857G200	V261	P.O.A.	6"	ESFR - 25.2 K	205	14863G200	V261	\$3,579.64
3"	ESFR - 25.2 K	250	14857G300	V261	P.O.A.	6"	ESFR - 25.2 K	250	14863G300	V261	\$3,579.64
4"	3/8" (2.8 K)	175	14860A175	V261	\$3,292.58	8"	3/8" (2.8 K)	175	15266A175	V261	\$4,789.20
4"	3/8" (2.8 K)	205	14860A200	V261	\$3,292.58	8"	3/8" (2.8 K)	205	15266A200	V261	\$4,789.20
4"	3/8" (2.8 K)	250	14860A300	V261	\$3,292.58	8"	3/8" (2.8 K)	250	15266A300	V261	\$4,789.20
4"	7/16" (4.2 K)	175	14860B175	V261	\$3,292.58	8"	7/16" (4.2 K)	175	15266B175	V261	\$4,789.20
4"	7/16" (4.2 K)	205	14860B200	V261	\$3,292.58	8"	7/16" (4.2 K)	205	15266B200	V261	\$4,789.20
4"	7/16" (4.2 K)	250	14860B300	V261	\$3,292.58	8"	7/16" (4.2 K)	250	15266B300	V261	\$4,789.20
4"	1/2" (5.6 K)	175	14860C175	V261	\$3,292.58	8"	1/2" (5.6 K)	175	15266C175	V261	\$4,789.20
4"	1/2" (5.6 K)	205	14860C200	V261	\$3,292.58	8"	1/2" (5.6 K)	205	15266C200	V261	\$4,789.20
4"	1/2" (5.6 K)	250	14860C300	V261	\$3,292.58	8"	1/2" (5.6 K)	250	15266C300	V261	\$4,789.20
4"	17/32" (8.0 K)	175	14860D175	V261	\$3,292.58	8"	17/32" (8.0 K)	175	15266D175	V261	\$4,789.20
4"	17/32" (8.0 K)	205	14860D200	V261	\$3,292.58	8"	17/32" (8.0 K)	205	15266D200	V261	\$4,789.20
4"	17/32" (8.0 K)	250	14860D300	V261	\$3,292.58	8"	17/32" (8.0 K)	250	15266D300	V261	\$4,789.20
4"	ELO (11.2 K)	175	14860E175	V261	\$3,292.58	8"	ELO (11.2 K)	175	15266E175	V261	\$4,789.20
4"	ELO (11.2 K)	205	14860E200	V261	\$3,292.58	8"	ELO (11.2 K)	205	15266E200	V261	\$4,789.20
4"	ELO (11.2 K)	250	14860E300	V261	\$3,292.58	8"	ELO (11.2 K)	250	15266E300	V261	\$4,789.20
4"	ESFR (14.0 K)	175	14860F175	V261	\$3,292.58	8"	ESFR (14.0 K)	175	15266F175	V261	\$4,789.20
4"	ESFR (14.0 K)	205	14860F200	V261	\$3,292.58	8"	ESFR (14.0 K)	205	15266F200	V261	\$4,789.20
4"	ESFR (14.0 K)	250	14860F300	V261	\$3,292.58	8"	ESFR (14.0 K)	250	15266F300	V261	\$4,789.20
4"	ESFR (25.2 K)	175	14860G175	V261	\$3,415.37	8"	ESFR (25.2 K)	175	15266G175	V261	\$4,789.20
4"	ESFR (25.2 K)	205	14860G200	V261	\$3,415.37	8"	ESFR (25.2 K)	205	15266G200	V261	\$4,789.20
4"	ESFR (25.2 K)	250	14860G300	V261	\$3,415.37	8"	ESFR (25.2 K)	250	15266G300	V261	\$4,789.20

(1) Refers to factory pressure setting (psi) of pressure relief valve (PRV).

TESTanDRAIN® is a registered trademark of AGF Manufacturing, Inc.



COMMERCIAL (with TESTanDRAIN® and PRV)											
Size	Orifice Size	PRV ¹	Part #	IPG	List Price	Size	Orifice Size	PRV ¹	Part #	IPG	List Price
Thread x Groove (schedule 40)						Thread x Thread (schedule 40)					
1-1/4"	3/8" (2.8 K)	175	15252A175	V261	\$2,432.39	1-1/4"	3/8" (2.8 K)	175	14873A175	V261	\$2,402.40
1-1/4"	3/8" (2.8 K)	205	15252A200	V261	\$2,432.39	1-1/4"	3/8" (2.8 K)	205	14873A200	V261	\$2,402.40
1-1/4"	3/8" (2.8 K)	250	15252A300	V261	\$2,432.39	1-1/4"	3/8" (2.8 K)	250	14873A300	V261	\$2,402.40
1-1/4"	7/16" (4.2 K)	175	15252B175	V261	\$2,432.39	1-1/4"	7/16" (4.2 K)	175	14873B175	V261	\$2,402.40
1-1/4"	7/16" (4.2 K)	205	15252B200	V261	\$2,432.39	1-1/4"	7/16" (4.2 K)	205	14873B200	V261	\$2,402.40
1-1/4"	7/16" (4.2 K)	250	15252B300	V261	\$2,432.39	1-1/4"	7/16" (4.2 K)	250	14873B300	V261	\$2,402.40
1-1/4"	1/2" (5.6 K)	175	15252C175	V261	\$2,432.39	1-1/4"	1/2" (5.6 K)	175	14873C175	V261	\$2,402.40
1-1/4"	1/2" (5.6 K)	205	15252C200	V261	\$2,432.39	1-1/4"	1/2" (5.6 K)	205	14873C200	V261	\$2,402.40
1-1/4"	1/2" (5.6 K)	250	15252C300	V261	\$2,432.39	1-1/4"	1/2" (5.6 K)	250	14873C300	V261	\$2,402.40
1-1/4"	17/32" (8.0 K)	175	15252D175	V261	\$2,432.39	1-1/4"	17/32" (8.0 K)	175	14873D175	V261	\$2,402.40
1-1/4"	17/32" (8.0 K)	205	15252D200	V261	\$2,432.39	1-1/4"	17/32" (8.0 K)	205	14873D200	V261	\$2,402.40
1-1/4"	17/32" (8.0 K)	250	15252D300	V261	\$2,432.39	1-1/4"	17/32" (8.0 K)	250	14873D300	V261	\$2,402.40
1-1/4"	ELO (11.2 K)	175	15252E175	V261	\$2,432.39	1-1/4"	ELO (11.2 K)	175	14873E175	V261	\$2,402.40
1-1/4"	ELO (11.2 K)	205	15252E200	V261	\$2,432.39	1-1/4"	ELO (11.2 K)	205	14873E200	V261	\$2,402.40
1-1/4"	ELO (11.2 K)	250	15252E300	V261	\$2,432.39	1-1/4"	ELO (11.2 K)	250	14873E300	V261	\$2,402.40
1-1/2"	3/8" (2.8 K)	175	15257A175	V261	\$2,414.61	1-1/2"	3/8" (2.8 K)	175	14877A175	V261	\$2,407.01
1-1/2"	3/8" (2.8 K)	205	15257A200	V261	\$2,414.61	1-1/2"	3/8" (2.8 K)	205	14877A200	V261	\$2,407.01
1-1/2"	3/8" (2.8 K)	250	15257A300	V261	\$2,414.61	1-1/2"	3/8" (2.8 K)	250	14877A300	V261	\$2,407.01
1-1/2"	7/16" (4.2 K)	175	15257B175	V261	\$2,414.61	1-1/2"	7/16" (4.2 K)	175	14877B175	V261	\$2,407.01
1-1/2"	7/16" (4.2 K)	205	15257B200	V261	\$2,414.61	1-1/2"	7/16" (4.2 K)	205	14877B200	V261	\$2,407.01
1-1/2"	7/16" (4.2 K)	250	15257B300	V261	\$2,414.61	1-1/2"	7/16" (4.2 K)	250	14877B300	V261	\$2,407.01
1-1/2"	1/2" (5.6 K)	175	15257C175	V261	\$2,414.61	1-1/2"	1/2" (5.6 K)	175	14877C175	V261	\$2,407.01
1-1/2"	1/2" (5.6 K)	205	15257C200	V261	\$2,414.61	1-1/2"	1/2" (5.6 K)	205	14877C200	V261	\$2,407.01
1-1/2"	1/2" (5.6 K)	250	15257C300	V261	\$2,414.61	1-1/2"	1/2" (5.6 K)	250	14877C300	V261	\$2,407.01
1-1/2"	17/32" (8.0 K)	175	15257D175	V261	\$2,414.61	1-1/2"	17/32" (8.0 K)	175	14877D175	V261	\$2,407.01
1-1/2"	17/32" (8.0 K)	205	15257D200	V261	\$2,414.61	1-1/2"	17/32" (8.0 K)	205	14877D200	V261	\$2,407.01
1-1/2"	17/32" (8.0 K)	250	15257D300	V261	\$2,414.61	1-1/2"	17/32" (8.0 K)	250	14877D300	V261	\$2,407.01
1-1/2"	ELO (11.2 K)	175	15257E175	V261	\$2,414.61	1-1/2"	ELO (11.2 K)	175	14877E175	V261	\$2,407.01
1-1/2"	ELO (11.2 K)	205	15257E200	V261	\$2,414.61	1-1/2"	ELO (11.2 K)	205	14877E200	V261	\$2,407.01
1-1/2"	ELO (11.2 K)	250	15257E300	V261	\$2,414.61	1-1/2"	ELO (11.2 K)	250	14877E300	V261	\$2,407.01
2"	3/8" (2.8 K)	175	15260A175	V261	\$2,827.16	2"	3/8" (2.8 K)	175	14847A175	V261	\$2,409.32
2"	3/8" (2.8 K)	205	15260A200	V261	\$2,827.16	2"	3/8" (2.8 K)	205	14847A200	V261	\$2,409.32
2"	3/8" (2.8 K)	250	15260A300	V261	\$2,827.16	2"	3/8" (2.8 K)	250	14847A300	V261	\$2,409.32
2"	7/16" (4.2 K)	175	15260B175	V261	\$2,827.16	2"	7/16" (4.2 K)	175	14847B175	V261	\$2,409.32
2"	7/16" (4.2 K)	205	15260B200	V261	\$2,827.16	2"	7/16" (4.2 K)	205	14847B200	V261	\$2,409.32
2"	7/16" (4.2 K)	250	15260B300	V261	\$2,827.16	2"	7/16" (4.2 K)	250	14847B300	V261	\$2,409.32
2"	1/2" (5.6 K)	175	15260C175	V261	\$2,827.16	2"	1/2" (5.6 K)	175	14847C175	V261	\$2,409.32
2"	1/2" (5.6 K)	205	15260C200	V261	\$2,827.16	2"	1/2" (5.6 K)	205	14847C200	V261	\$2,409.32
2"	1/2" (5.6 K)	250	15260C300	V261	\$2,827.16	2"	1/2" (5.6 K)	250	14847C300	V261	\$2,409.32
2"	17/32" (8.0 K)	175	15260D175	V261	\$2,827.16	2"	17/32" (8.0 K)	175	14847D175	V261	\$2,409.32
2"	17/32" (8.0 K)	205	15260D200	V261	\$2,827.16	2"	17/32" (8.0 K)	205	14847D200	V261	\$2,409.32
2"	17/32" (8.0 K)	250	15260D300	V261	\$2,827.16	2"	17/32" (8.0 K)	250	14847D300	V261	\$2,409.32
2"	ELO (11.2 K)	175	15260E175	V261	\$2,827.16	2"	ELO (11.2 K)	175	14847E175	V261	\$2,400.54
2"	ELO (11.2 K)	205	15260E200	V261	\$2,827.16	2"	ELO (11.2 K)	205	14847E200	V261	\$2,400.54
2"	ELO (11.2 K)	250	15260E300	V261	\$2,827.16	2"	ELO (11.2 K)	250	14847E300	V261	\$2,400.54

(1) Refers to factory pressure setting (psi) of pressure relief valve (PRV).

TESTanDRAIN® is a registered trademark of AGF Manufacturing, Inc.

EasyPac™ FLOOR CONTROL Riser Assemblies		
Basic (w/ ball valve)	TESTanDRAIN®	TESTanDRAIN® & PRV
Features and Benefits of all EasyPac™ Riser Assemblies <ul style="list-style-type: none"> - Assembled in the United States. - Made with UL listed and FM approved components. - Field replaceable parts for ease of service. - Fabricated steel riser body with black powder coat finish. - Compact, lightweight design for easy installation. - Built-in test port allows hydrostatic testing w/out draining system. - Pressure rating: 250 PSI max water working pressure. - Includes Potter® VSR flow switch. 		

Floor Control - Basic (with ball valve)			
Size	Part #	IPG	List Price
Groove x Groove (schedule 10)			
1-1/4"	15270	V262	\$1,405.28
1-1/2"	15279	V262	\$1,500.47
2"	15288	V262	\$1,346.31
2-1/2"	15297	V262	\$1,360.49
3"	15300	V262	\$1,552.17
4"	15303	V262	\$1,809.46
6"	15294	V262	\$1,929.00
8"	15261	V262	\$2,271.64
Thread x Groove (schedule 40)			
1-1/4"	15273	V262	\$1,440.25
1-1/2"	15282	V262	\$1,512.55
2"	15291	V262	\$1,378.50
Thread x Thread (schedule 40)			
1-1/4"	15267	V262	\$1,407.34
1-1/2"	15276	V262	\$1,503.52
2"	15285	V262	\$1,390.03

FLOOR CONTROL (with TESTanDRAIN®)									
Size	Orifice Size	Part #	IPG	List Price	Size	Orifice Size	Part #	IPG	List Price
Groove x Groove (schedule 10)					Groove x Groove (schedule 10)				
1-1/4"	3/8" (2.8 K)	15271A	V262	\$2,369.61	3"	3/8" (2.8 K)	15301A	V262	\$2,455.67
1-1/4"	7/16" (4.2 K)	15271B	V262	\$2,369.61	3"	7/16" (4.2 K)	15301B	V262	\$2,455.67
1-1/4"	1/2" (5.6 K)	15271C	V262	\$2,369.61	3"	1/2" (5.6 K)	15301C	V262	\$2,455.67
1-1/4"	17/32" (8.0 K)	15271D	V262	\$2,369.61	3"	17/32" (8.0 K)	15301D	V262	\$2,455.67
1-1/4"	ELO (11.2 K)	15271E	V262	\$2,369.61	3"	ELO (11.2 K)	15301E	V262	\$2,455.67
					3"	ESFR (14.0 K)	15301F	V262	\$2,455.67
					3"	ESFR (25.2 K)	15301G	V262	P.O.A.
					4"	3/8" (2.8 K)	15304A	V262	\$3,349.55
1-1/2"	3/8" (2.8 K)	15280A	V262	\$2,372.99	4"	7/16" (4.2 K)	15304B	V262	\$3,349.55
1-1/2"	7/16" (4.2 K)	15280B	V262	\$2,372.99	4"	1/2" (5.6 K)	15304C	V262	\$3,349.55
1-1/2"	1/2" (5.6 K)	15280C	V262	\$2,372.99	4"	17/32" (8.0 K)	15304D	V262	\$3,349.55
1-1/2"	17/32" (8.0 K)	15280D	V262	\$2,372.99	4"	ELO (11.2 K)	15304E	V262	\$3,349.55
1-1/2"	ELO (11.2 K)	15280E	V262	\$2,372.99	4"	ESFR (14.0 K)	15304F	V262	\$3,349.55
					4"	ESFR (25.2 K)	15304G	V262	P.O.A.
					6"	3/8" (2.8 K)	15295A	V262	\$3,529.81
2"	3/8" (2.8 K)	15289A	V262	\$2,336.82	6"	7/16" (4.2 K)	15295B	V262	\$3,529.81
2"	7/16" (4.2 K)	15289B	V262	\$2,336.82	6"	1/2" (5.6 K)	15295C	V262	\$3,529.81
2"	1/2" (5.6 K)	15289C	V262	\$2,336.82	6"	17/32" (8.0 K)	15295D	V262	\$3,529.81
2"	17/32" (8.0 K)	15289D	V262	\$2,336.82	6"	ELO (11.2 K)	15295E	V262	\$3,529.81
2"	ELO (11.2 K)	15289E	V262	\$2,336.82	6"	ESFR (14.0 K)	15295F	V262	\$3,529.81
					6"	ESFR (25.2 K)	15295G	V262	P.O.A.
					8"	3/8" (2.8 K)	15262A	V262	\$3,907.98
2-1/2"	3/8" (2.8 K)	15298A	V262	\$2,355.34	8"	7/16" (4.2 K)	15262B	V262	\$3,907.98
2-1/2"	7/16" (4.2 K)	15298B	V262	\$2,355.34	8"	1/2" (5.6 K)	15262C	V262	\$3,907.98
2-1/2"	1/2" (5.6 K)	15298C	V262	\$2,355.34	8"	17/32" (8.0 K)	15262D	V262	\$3,907.98
2-1/2"	17/32" (8.0 K)	15298D	V262	\$2,355.34	8"	ELO (11.2 K)	15262E	V262	\$3,907.98
2-1/2"	ELO (11.2 K)	15298E	V262	\$2,355.34	8"	ESFR (14.0 K)	15262F	V262	\$3,907.98
2-1/2"	ESFR (14.0 K)	15298F	V262	\$2,355.34	8"	ESFR (25.2 K)	15262G	V262	\$4,051.31
2-1/2"	ESFR (25.2 K)	15298G	V262	P.O.A.					

TESTanDRAIN® is a registered trademark of AGF Manufacturing, Inc.



FLOOR CONTROL (with TESTanDRAIN®)									
Size	Orifice Size	Part #	IPG	List Price	Size	Orifice Size	Part #	IPG	List Price
Thread x Groove (schedule 40)					Thread x Thread (schedule 40)				
1-1/4"	3/8" (2.8 K)	15274A	V262	\$2,404.57	1-1/4"	3/8" (2.8 K)	15268A	V262	\$2,371.64
1-1/4"	7/16" (4.2 K)	15274B	V262	\$2,404.57	1-1/4"	7/16" (4.2 K)	15268B	V262	\$2,371.64
1-1/4"	1/2" (5.6 K)	15274C	V262	\$2,404.57	1-1/4"	1/2" (5.6 K)	15268C	V262	\$2,371.64
1-1/4"	17/32" (8.0 K)	15274D	V262	\$2,404.57	1-1/4"	17/32" (8.0 K)	15268D	V262	\$2,371.64
1-1/4"	17/32" (8.0 K)	15274E	V262	\$2,404.57	1-1/4"	17/32" (8.0 K)	15268E	V262	\$2,371.64
1-1/2"	3/8" (2.8 K)	15283A	V262	\$2,385.08	1-1/2"	3/8" (2.8 K)	15277A	V262	\$2,376.76
1-1/2"	7/16" (4.2 K)	15283B	V262	\$2,385.08	1-1/2"	7/16" (4.2 K)	15277B	V262	\$2,376.76
1-1/2"	1/2" (5.6 K)	15283C	V262	\$2,385.08	1-1/2"	1/2" (5.6 K)	15277C	V262	\$2,376.76
1-1/2"	17/32" (8.0 K)	15283D	V262	\$2,385.08	1-1/2"	17/32" (8.0 K)	15277D	V262	\$2,376.76
1-1/2"	17/32" (8.0 K)	15283E	V262	\$2,385.08	1-1/2"	17/32" (8.0 K)	15277E	V262	\$2,376.76
2"	3/8" (2.8 K)	15292A	V262	\$2,369.05	2"	3/8" (2.8 K)	15286A	V262	\$2,380.56
2"	7/16" (4.2 K)	15292B	V262	\$2,369.05	2"	7/16" (4.2 K)	15286B	V262	\$2,380.56
2"	1/2" (5.6 K)	15292C	V262	\$2,369.05	2"	1/2" (5.6 K)	15286C	V262	\$2,380.56
2"	17/32" (8.0 K)	15292D	V262	\$2,369.05	2"	17/32" (8.0 K)	15286D	V262	\$2,380.56
2"	ELO (11.2 K)	15292E	V262	\$2,369.05	2"	ELO (11.2 K)	15286E	V262	\$2,380.56

FLOOR CONTROL (with TESTanDRAIN® and PRV)											
Size	Orifice Size	PRV ¹	Part #	IPG	List Price	Size	Orifice Size	PRV ¹	Part #	IPG	List Price
Groove x Groove (schedule 10)						Groove x Groove (schedule 10)					
1-1/4"	3/8" (2.8 K)	175	15272A175	V262	\$2,632.56	2"	3/8" (2.8 K)	175	15290A175	V262	\$2,604.49
1-1/4"	3/8" (2.8 K)	205	15272A200	V262	\$2,632.56	2"	3/8" (2.8 K)	205	15290A200	V262	\$2,604.49
1-1/4"	3/8" (2.8 K)	250	15272A300	V262	\$2,632.56	2"	3/8" (2.8 K)	250	15290A300	V262	\$2,604.49
1-1/4"	7/16" (4.2 K)	175	15272B175	V262	\$2,632.56	2"	7/16" (4.2 K)	175	15290B175	V262	\$2,604.49
1-1/4"	7/16" (4.2 K)	205	15272B200	V262	\$2,632.56	2"	7/16" (4.2 K)	205	15290B200	V262	\$2,604.49
1-1/4"	7/16" (4.2 K)	250	15272B300	V262	\$2,632.56	2"	7/16" (4.2 K)	250	15290B300	V262	\$2,604.49
1-1/4"	1/2" (5.6 K)	175	15272C175	V262	\$2,632.56	2"	1/2" (5.6 K)	175	15290C175	V262	\$2,604.49
1-1/4"	1/2" (5.6 K)	205	15272C200	V262	\$2,632.56	2"	1/2" (5.6 K)	205	15290C200	V262	\$2,604.49
1-1/4"	1/2" (5.6 K)	250	15272C300	V262	\$2,632.56	2"	1/2" (5.6 K)	250	15290C300	V262	\$2,604.49
1-1/4"	17/32" (8.0 K)	175	15272D175	V262	\$2,632.56	2"	17/32" (8.0 K)	175	15290D175	V262	\$2,604.49
1-1/4"	17/32" (8.0 K)	205	15272D200	V262	\$2,632.56	2"	17/32" (8.0 K)	205	15290D200	V262	\$2,604.49
1-1/4"	17/32" (8.0 K)	250	15272D300	V262	\$2,632.56	2"	17/32" (8.0 K)	250	15290D300	V262	\$2,604.49
1-1/4"	ELO (11.2 K)	175	15272E175	V262	\$2,632.56	2"	ELO (11.2 K)	175	15290E175	V262	\$2,604.49
1-1/4"	ELO (11.2 K)	205	15272E200	V262	\$2,632.56	2"	ELO (11.2 K)	205	15290E200	V262	\$2,604.49
1-1/4"	ELO (11.2 K)	250	15272E300	V262	\$2,632.56	2"	ELO (11.2 K)	250	15290E300	V262	\$2,604.49
1-1/2"	3/8" (2.8 K)	175	15281A175	V262	\$2,635.99	2-1/2"	3/8" (2.8 K)	175	15299A175	V262	\$2,623.44
1-1/2"	3/8" (2.8 K)	205	15281A200	V262	\$2,635.99	2-1/2"	3/8" (2.8 K)	205	15299A200	V262	\$2,623.44
1-1/2"	3/8" (2.8 K)	250	15281A300	V262	\$2,635.99	2-1/2"	3/8" (2.8 K)	250	15299A300	V262	\$2,623.44
1-1/2"	7/16" (4.2 K)	175	15281B175	V262	\$2,635.99	2-1/2"	7/16" (4.2 K)	175	15299B175	V262	\$2,623.44
1-1/2"	7/16" (4.2 K)	205	15281B200	V262	\$2,635.99	2-1/2"	7/16" (4.2 K)	205	15299B200	V262	\$2,623.44
1-1/2"	7/16" (4.2 K)	250	15281B300	V262	\$2,635.99	2-1/2"	7/16" (4.2 K)	250	15299B300	V262	\$2,623.44
1-1/2"	1/2" (5.6 K)	175	15281C175	V262	\$2,635.99	2-1/2"	1/2" (5.6 K)	175	15299C175	V262	\$2,623.44
1-1/2"	1/2" (5.6 K)	205	15281C200	V262	\$2,635.99	2-1/2"	1/2" (5.6 K)	205	15299C200	V262	\$2,623.44
1-1/2"	1/2" (5.6 K)	250	15281C300	V262	\$2,635.99	2-1/2"	1/2" (5.6 K)	250	15299C300	V262	\$2,623.44
1-1/2"	17/32" (8.0 K)	175	15281D175	V262	\$2,635.99	2-1/2"	17/32" (8.0 K)	175	15299D175	V262	\$2,623.44
1-1/2"	17/32" (8.0 K)	205	15281D200	V262	\$2,635.99	2-1/2"	17/32" (8.0 K)	205	15299D200	V262	\$2,623.44
1-1/2"	17/32" (8.0 K)	250	15281D300	V262	\$2,635.99	2-1/2"	17/32" (8.0 K)	250	15299D300	V262	\$2,623.44
1-1/2"	ELO (11.2 K)	175	15281E175	V262	\$2,635.99	2-1/2"	ELO (11.2 K)	175	15298E175	V262	P.O.A.
1-1/2"	ELO (11.2 K)	205	15281E200	V262	\$2,635.99	2-1/2"	ELO (11.2 K)	205	1.53E+204	V262	P.O.A.
1-1/2"	ELO (11.2 K)	250	15281E300	V262	\$2,635.99	2-1/2"	ELO (11.2 K)	250	1.53E+304	V262	P.O.A.
						2-1/2"	ESFR (14.0 K)	175	15299F175	V262	\$2,623.44
						2-1/2"	ESFR (14.0 K)	205	15299F200	V262	\$2,623.44
						2-1/2"	ESFR (14.0 K)	250	15299F300	V262	\$2,623.44

(1) Refers to factory pressure setting (psi) of pressure relief valve (PRV).



FLOOR CONTROL (with TESTanDRAIN® and PRV)											
Size	Orifice Size	PRV ¹	Part #	IPG	List Price	Size	Orifice Size	PRV ¹	Part #	IPG	List Price
Groove x Groove (schedule 10)						Groove x Groove (schedule 10)					
3"	3/8" (2.8 K)	175	15302A175	V262	\$2,815.13	6"	3/8" (2.8 K)	175	15296A175	V262	\$3,792.78
3"	3/8" (2.8 K)	205	15302A200	V262	\$2,815.13	6"	3/8" (2.8 K)	205	15296A200	V262	\$3,792.78
3"	3/8" (2.8 K)	250	15302A300	V262	\$2,815.13	6"	3/8" (2.8 K)	250	15296A300	V262	\$3,792.78
3"	7/16" (4.2 K)	175	15302B175	V262	\$2,815.13	6"	7/16" (4.2 K)	175	15296B175	V262	\$3,792.78
3"	7/16" (4.2 K)	205	15302B200	V262	\$2,815.13	6"	7/16" (4.2 K)	205	15296B200	V262	\$3,792.78
3"	7/16" (4.2 K)	250	15302B300	V262	\$2,815.13	6"	7/16" (4.2 K)	250	15296B300	V262	\$3,792.78
3"	1/2" (5.6 K)	175	15302C175	V262	\$2,815.13	6"	1/2" (5.6 K)	175	15296C175	V262	\$3,792.78
3"	1/2" (5.6 K)	205	15302C200	V262	\$2,815.13	6"	1/2" (5.6 K)	205	15296C200	V262	\$3,792.78
3"	1/2" (5.6 K)	250	15302C300	V262	\$2,815.13	6"	1/2" (5.6 K)	250	15296C300	V262	\$3,792.78
3"	17/32" (8.0 K)	175	15302D175	V262	\$2,815.13	6"	17/32" (8.0 K)	175	15296D175	V262	\$3,792.78
3"	17/32" (8.0 K)	205	15302D200	V262	\$2,815.13	6"	17/32" (8.0 K)	205	15296D200	V262	\$3,792.78
3"	17/32" (8.0 K)	250	15302D300	V262	\$2,815.13	6"	17/32" (8.0 K)	250	15296D300	V262	\$3,792.78
3"	ELO (11.2 K)	175	15302E175	V262	\$2,815.13	6"	ELO (11.2 K)	175	15296E175	V262	\$3,792.78
3"	ELO (11.2 K)	205	15302E200	V262	\$2,815.13	6"	ELO (11.2 K)	205	15296E200	V262	\$3,792.78
3"	ELO (11.2 K)	250	15302E300	V262	\$2,815.13	6"	ELO (11.2 K)	250	15296E300	V262	\$3,792.78
3"	ESFR (14.0 K)	175	15302F175	V262	\$2,815.13	6"	ESFR (14.0 K)	175	15296F175	V262	\$3,792.78
3"	ESFR (14.0 K)	205	15302F200	V262	\$2,815.13	6"	ESFR (14.0 K)	205	15296F200	V262	\$3,792.78
3"	ESFR (14.0 K)	250	15302F300	V262	\$2,815.13	6"	ESFR (14.0 K)	250	15296F300	V262	\$3,792.78
3"	ESFR (25.2 K)	175	15302G175	V262	P.O.A.	6"	ESFR (25.2 K)	175	15296G175	V262	\$3,792.78
3"	ESFR (25.2 K)	205	15302G200	V262	P.O.A.	6"	ESFR (25.2 K)	205	15296G200	V262	P.O.A.
3"	ESFR (25.2 K)	250	15302G300	V262	P.O.A.	6"	ESFR (25.2 K)	250	15296G300	V262	P.O.A.
4"	3/8" (2.8 K)	175	15305A175	V262	\$3,612.51	8"	3/8" (2.8 K)	175	15263A175	V262	\$4,187.41
4"	3/8" (2.8 K)	205	15305A200	V262	\$3,612.51	8"	3/8" (2.8 K)	205	15263A200	V262	\$4,187.41
4"	3/8" (2.8 K)	250	15305A300	V262	\$3,612.51	8"	3/8" (2.8 K)	250	15263A300	V262	\$4,187.41
4"	7/16" (4.2 K)	175	15305B175	V262	\$3,612.51	8"	7/16" (4.2 K)	175	15263B175	V262	\$4,187.41
4"	7/16" (4.2 K)	205	15305B200	V262	\$3,612.51	8"	7/16" (4.2 K)	205	15263B200	V262	\$4,187.41
4"	7/16" (4.2 K)	250	15305B300	V262	\$3,612.51	8"	7/16" (4.2 K)	250	15263B300	V262	\$4,187.41
4"	1/2" (5.6 K)	175	15305C175	V262	\$3,612.51	8"	1/2" (5.6 K)	175	15263C175	V262	\$4,187.41
4"	1/2" (5.6 K)	205	15305C200	V262	\$3,612.51	8"	1/2" (5.6 K)	205	15263C200	V262	\$4,187.41
4"	1/2" (5.6 K)	250	15305C300	V262	\$3,612.51	8"	1/2" (5.6 K)	250	15263C300	V262	\$4,187.41
4"	17/32" (8.0 K)	175	15305D175	V262	\$3,612.51	8"	17/32" (8.0 K)	175	15263D175	V262	\$4,187.41
4"	17/32" (8.0 K)	205	15305D200	V262	\$3,612.51	8"	17/32" (8.0 K)	205	15263D200	V262	\$4,187.41
4"	17/32" (8.0 K)	250	15305D300	V262	\$3,612.51	8"	17/32" (8.0 K)	250	15263D300	V262	\$4,187.41
4"	ELO (11.2 K)	175	15305E175	V262	\$3,612.51	8"	ELO (11.2 K)	175	15263E175	V262	\$4,187.41
4"	ELO (11.2 K)	205	15305E200	V262	\$3,612.51	8"	ELO (11.2 K)	205	15263E200	V262	\$4,187.41
4"	ELO (11.2 K)	250	15305E300	V262	\$3,612.51	8"	ELO (11.2 K)	250	15263E300	V262	\$4,187.41
4"	ESFR (14.0 K)	175	15305F175	V262	\$3,612.51	8"	ESFR (14.0 K)	175	15263F175	V262	\$4,187.41
4"	ESFR (14.0 K)	205	15305F200	V262	\$3,612.51	8"	ESFR (14.0 K)	205	15263F200	V262	\$4,187.41
4"	ESFR (14.0 K)	250	15305F300	V262	\$3,612.51	8"	ESFR (14.0 K)	250	15263F300	V262	\$4,187.41
4"	ESFR (25.2 K)	175	15305G175	V262	P.O.A.	8"	ESFR (25.2 K)	175	15263G175	V262	\$4,330.71
4"	ESFR (25.2 K)	205	15305G200	V262	P.O.A.	8"	ESFR (25.2 K)	205	15263G200	V262	\$4,330.71
4"	ESFR (25.2 K)	250	15305G300	V262	P.O.A.	8"	ESFR (25.2 K)	250	15263G300	V262	\$4,330.71

(1) Refers to factory pressure setting (psi) of pressure relief valve (PRV).

TESTanDRAIN® is a registered trademark of AGF Manufacturing, Inc.

FLOOR CONTROL (with TESTanDRAIN® and PRV)											
Size	Orifice Size	PRV ¹	Part #	IPG	List Price	Size	Orifice Size	PRV ¹	Part #	IPG	List Price
Thread x Groove (schedule 40)						Thread x Thread (schedule 40)					
1-1/4"	3/8" (2.8 K)	175	15275A175	V262	\$2,667.53	1-1/4"	3/8" (2.8 K)	175	15269A175	V262	\$2,634.62
1-1/4"	3/8" (2.8 K)	205	15275A200	V262	\$2,667.53	1-1/4"	3/8" (2.8 K)	205	15269A200	V262	\$2,634.62
1-1/4"	3/8" (2.8 K)	250	15275A300	V262	\$2,667.53	1-1/4"	3/8" (2.8 K)	250	15269A300	V262	\$2,634.62
1-1/4"	7/16" (4.2 K)	175	15275B175	V262	\$2,667.53	1-1/4"	7/16" (4.2 K)	175	15269B175	V262	\$2,634.62
1-1/4"	7/16" (4.2 K)	205	15275B200	V262	\$2,667.53	1-1/4"	7/16" (4.2 K)	205	15269B200	V262	\$2,634.62
1-1/4"	7/16" (4.2 K)	250	15275B300	V262	\$2,667.53	1-1/4"	7/16" (4.2 K)	250	15269B300	V262	\$2,634.62
1-1/4"	1/2" (5.6 K)	175	15275C175	V262	\$2,667.53	1-1/4"	1/2" (5.6 K)	175	15269C175	V262	\$2,634.62
1-1/4"	1/2" (5.6 K)	205	15275C200	V262	\$2,667.53	1-1/4"	1/2" (5.6 K)	205	15269C200	V262	\$2,634.62
1-1/4"	1/2" (5.6 K)	250	15275C300	V262	\$2,667.53	1-1/4"	1/2" (5.6 K)	250	15269C300	V262	\$2,634.62
1-1/4"	17/32" (8.0 K)	175	15275D175	V262	\$2,667.53	1-1/4"	17/32" (8.0 K)	175	15269D175	V262	\$2,634.62
1-1/4"	17/32" (8.0 K)	205	15275D200	V262	\$2,667.53	1-1/4"	17/32" (8.0 K)	205	15269D200	V262	\$2,634.62
1-1/4"	17/32" (8.0 K)	250	15275D300	V262	\$2,667.53	1-1/4"	17/32" (8.0 K)	250	15269D300	V262	\$2,634.62
1-1/4"	ELO (11.2 K)	175	15275E175	V262	\$2,667.53	1-1/4"	ELO (11.2 K)	175	15269E175	V262	\$2,634.62
1-1/4"	ELO (11.2 K)	205	15275E200	V262	\$2,667.53	1-1/4"	ELO (11.2 K)	205	15269E200	V262	\$2,634.62
1-1/4"	ELO (11.2 K)	250	15275E300	V262	\$2,667.53	1-1/4"	ELO (11.2 K)	250	15269E300	V262	\$2,643.62
1-1/2"	3/8" (2.8 K)	175	15284A175	V262	\$2,648.05	1-1/2"	3/8" (2.8 K)	175	15278A175	V262	\$2,639.70
1-1/2"	3/8" (2.8 K)	205	15284A200	V262	\$2,648.05	1-1/2"	3/8" (2.8 K)	205	15278A200	V262	\$2,639.70
1-1/2"	3/8" (2.8 K)	250	15284A300	V262	\$2,648.05	1-1/2"	3/8" (2.8 K)	250	15278A300	V262	\$2,639.70
1-1/2"	7/16" (4.2 K)	175	15284B175	V262	\$2,648.05	1-1/2"	7/16" (4.2 K)	175	15278B175	V262	\$2,639.70
1-1/2"	7/16" (4.2 K)	205	15284B200	V262	\$2,648.05	1-1/2"	7/16" (4.2 K)	205	15278B200	V262	\$2,639.70
1-1/2"	7/16" (4.2 K)	250	15284B300	V262	\$2,648.05	1-1/2"	7/16" (4.2 K)	250	15278B300	V262	\$2,639.70
1-1/2"	1/2" (5.6 K)	175	15284C175	V262	\$2,648.05	1-1/2"	1/2" (5.6 K)	175	15278C175	V262	\$2,639.70
1-1/2"	1/2" (5.6 K)	205	15284C200	V262	\$2,648.05	1-1/2"	1/2" (5.6 K)	205	15278C200	V262	\$2,639.70
1-1/2"	1/2" (5.6 K)	250	15284C300	V262	\$2,648.05	1-1/2"	1/2" (5.6 K)	250	15278C300	V262	\$2,639.70
1-1/2"	17/32" (8.0 K)	175	15284D175	V262	\$2,648.05	1-1/2"	17/32" (8.0 K)	175	15278D175	V262	\$2,639.70
1-1/2"	17/32" (8.0 K)	205	15284D200	V262	\$2,648.05	1-1/2"	17/32" (8.0 K)	205	15278D200	V262	\$2,639.70
1-1/2"	17/32" (8.0 K)	250	15284D300	V262	\$2,648.05	1-1/2"	17/32" (8.0 K)	250	15278D300	V262	\$2,639.70
1-1/2"	ELO (11.2 K)	175	15284E175	V262	\$2,648.05	1-1/2"	ELO (11.2 K)	175	15278E175	V262	\$2,639.70
1-1/2"	ELO (11.2 K)	205	15284E200	V262	\$2,648.05	1-1/2"	ELO (11.2 K)	205	15278E200	V262	\$2,639.70
1-1/2"	ELO (11.2 K)	250	15284E300	V262	\$2,648.05	1-1/2"	ELO (11.2 K)	250	15278E300	V262	\$2,639.70
2"	3/8" (2.8 K)	175	15293A175	V262	\$2,636.71	2"	3/8" (2.8 K)	175	15287A175	V262	\$2,648.22
2"	3/8" (2.8 K)	205	15293A200	V262	\$2,636.71	2"	3/8" (2.8 K)	205	15287A200	V262	\$2,648.22
2"	3/8" (2.8 K)	250	15293A300	V262	\$2,636.71	2"	3/8" (2.8 K)	250	15287A300	V262	\$2,648.22
2"	7/16" (4.2 K)	175	15293B175	V262	\$2,636.71	2"	7/16" (4.2 K)	175	15287B175	V262	\$2,648.22
2"	7/16" (4.2 K)	205	15293B200	V262	\$2,636.71	2"	7/16" (4.2 K)	205	15287B200	V262	\$2,648.22
2"	7/16" (4.2 K)	250	15293B300	V262	\$2,636.71	2"	7/16" (4.2 K)	250	15287B300	V262	\$2,648.22
2"	1/2" (5.6 K)	175	15293C175	V262	\$2,636.71	2"	1/2" (5.6 K)	175	15287C175	V262	\$2,648.22
2"	1/2" (5.6 K)	205	15293C200	V262	\$2,636.71	2"	1/2" (5.6 K)	205	15287C200	V262	\$2,648.22
2"	1/2" (5.6 K)	250	15293C300	V262	\$2,636.71	2"	1/2" (5.6 K)	250	15287C300	V262	\$2,648.22
2"	17/32" (8.0 K)	175	15293D175	V262	\$2,636.71	2"	17/32" (8.0 K)	175	15287D175	V262	\$2,648.22
2"	17/32" (8.0 K)	205	15293D200	V262	\$2,636.71	2"	17/32" (8.0 K)	205	15287D200	V262	\$2,648.22
2"	17/32" (8.0 K)	250	15293D300	V262	\$2,636.71	2"	17/32" (8.0 K)	250	15287D300	V262	\$2,648.22
2"	ELO (11.2 K)	175	15293E175	V262	\$2,636.71	2"	ELO (11.2 K)	175	15287E175	V262	\$2,648.22
2"	ELO (11.2 K)	205	15293E200	V262	\$2,636.71	2"	ELO (11.2 K)	205	15287E200	V262	\$2,648.22
2"	ELO (11.2 K)	250	15293E300	V262	\$2,636.71	2"	ELO (11.2 K)	250	15287E300	V262	\$2,648.22

(1) Refers to factory pressure setting (psi) of pressure relief valve (PRV).

TESTanDRAIN® is a registered trademark of AGF Manufacturing, Inc.

EasyPac™ STANDPIPE Assemblies

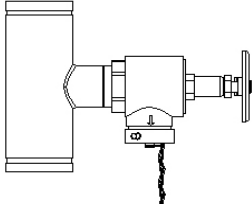
- Pressure Rating: 300 PSI (20.7 bar) max water working pressure.
- Fabricated steel pipe riser bodies with black E-coat.
- Available in grooved inlet and outlet connections (schedule 10 pipe).
- Includes 2-1/2" drain valve with cap and chain.

Standpipe Assemblies			
Size	Part #	IPG	List Price
International			
3"	15576	V253	\$1,604.25
4"	15577	V253	\$1,617.65
6"	15578	V253	\$1,713.40
DOMESTIC¹			
3"	15573	V253	\$3,081.12
4"	15574	V253	\$3,094.51
6"	15575	V253	\$3,190.31

(1) Domestic part numbers include
 100% US made components.