



TABLE OF CONTENTS

Model VXD Preaction Systems..... 0-1 – 0-2

Single Interlocked – Pneumatic Release.....0-3 – 0-4

Single Interlocked – Electric Release0-5 – 0-6

Double Interlocked – Pneumatic/Pneumatic Release..... 0-7– 0-8

Double Interlocked – Electric/Pneumatic Release 0-9 – 0-10

Double Interlocked – Electric/Pneumatic Release 0-11 – 0-12

SureFire® Preaction Systems 0-13 – 0-14

Components and Accessories (general) 0-15

Accessories (Pneumatic Release, Hydraulic Release) 0-16

Accessories (Electric Release) 0-17

Alarm Devices..... 0-18

Special Valves and Trim (Halar® coated valves, brass trim, etc.) 0-19 – 0-20

Notes

1. Refer to Viking technical data pages for complete product specifications. You may print or download technical data by visiting www.vikinggroupinc.com.
2. List prices effective July 9, 2022. Supersedes February 2022 list price book.
3. All sales by Viking are subject to the Terms & Conditions found on the last page of this book.

SureFire® is a registered trademark of The Viking Corporation

Model VXD Preaction Systems



Viking Model VXD Pretrimmed Risers (PTR)

Deluge with Electric Release IPG V404

| 1-1/2" | 2" | 2-1/2" | 3" | 4" | 6" | 8" |
|--------------|--------------|--------------|--------------|--------------|--------------|--------------|
| <u>24883</u> | <u>24893</u> | <u>25464</u> | <u>25396</u> | <u>25411</u> | <u>25437</u> | <u>25497</u> |
| \$10,136.51 | \$11,319.88 | \$13,122.15 | \$13,122.15 | \$14,008.23 | \$17,039.12 | \$28,868.64 |

Single Interlock Preaction with Electric Release IPG V405

| 1-1/2" | 2" | 2-1/2" | 3" | 4" | 6" | 8" |
|--------------|--------------|--------------|--------------|--------------|--------------|--------------|
| <u>24887</u> | <u>24897</u> | <u>25466</u> | <u>25398</u> | <u>25413</u> | <u>25439</u> | <u>25499</u> |
| \$10,820.23 | \$11,423.45 | \$13,509.41 | \$13,509.41 | \$16,344.94 | \$18,901.82 | \$30,049.58 |

Double Interlock with Electric/Pneumatic Release IPG V405

| 1-1/2" | 2" | 2-1/2" | 3" | 4" | 6" | 8" |
|--------------|--------------|--------------|--------------|--------------|--------------|--------------|
| <u>24891</u> | <u>24901</u> | <u>25468</u> | <u>25400</u> | <u>25415</u> | <u>25441</u> | <u>25501</u> |
| \$11,503.76 | \$12,541.51 | \$14,236.88 | \$14,236.88 | \$17,827.49 | \$19,832.20 | \$31,435.09 |

Double Interlock with Electric/Pneu-Lectric Release IPG V405

| 1-1/2" | 2" | 2-1/2" | 3" | 4" | 6" | 8" |
|--------------|--------------|--------------|--------------|--------------|--------------|--------------|
| <u>24887</u> | <u>24897</u> | <u>25466</u> | <u>25398</u> | <u>25413</u> | <u>25439</u> | <u>25499</u> |
| \$10,820.23 | \$11,423.45 | \$13,509.41 | \$13,509.41 | \$16,344.94 | \$18,901.82 | \$30,049.58 |

VXD Preaction Valves - Pretrimmed Deluge Valves

Pre-trimmed Electric Release Preaction Galvanized IPG V403

| 1-1/2" | 2" | 2-1/2" | 3" | 4" | 6" | 8" | 10" |
|--------------|--------------|--------------|--------------|--------------|--------------|--------------|--------------|
| <u>23563</u> | <u>23584</u> | <u>23605</u> | <u>23626</u> | <u>23647</u> | <u>23669</u> | <u>23690</u> | <u>23751</u> |
| \$9,626.24 | \$10,102.12 | \$11,314.01 | \$11,471.78 | \$12,281.62 | \$14,721.70 | \$26,131.39 | \$32,104.92 |

Pre-trimmed Pneumatic Release Preaction Galvanized IPG V403

| 1-1/2" | 2" | 2-1/2" | 3" | 4" | 6" | 8" | 10" |
|--------------|--------------|--------------|--------------|--------------|--------------|--------------|--------------|
| <u>23566</u> | <u>23587</u> | <u>23608</u> | <u>23629</u> | <u>23651</u> | <u>23672</u> | <u>23693</u> | <u>23754</u> |
| \$9,626.25 | \$10,102.13 | \$11,314.02 | \$11,471.77 | \$12,281.62 | \$14,721.70 | \$26,131.39 | \$32,104.92 |

Pre-trimmed Electric/Pneumatic Release Preaction Galvanized IPG V403

| 1-1/2" | 2" | 2-1/2" | 3" | 4" | 6" | 8" | 10" |
|--------------|--------------|--------------|--------------|--------------|--------------|--------------|--------------|
| <u>23569</u> | <u>23590</u> | <u>23611</u> | <u>23632</u> | <u>23654</u> | <u>23675</u> | <u>23696</u> | <u>23757</u> |
| \$10,495.82 | \$10,971.70 | \$12,183.59 | \$12,341.36 | \$13,151.20 | \$15,591.28 | \$27,000.97 | \$32,974.50 |

Model VXD Praction Systems

VXD Praction Valves - Pretrimmed Deluge Valves

Pre-trimmed Electric Release Praction Galvanized IPG V403

| 1-1/2" | 2" | 2-1/2" | 3" | 4" | 6" | 8" | 10" |
|--------------|--------------|--------------|--------------|--------------|--------------|--------------|--------------|
| <u>23563</u> | <u>23584</u> | <u>23605</u> | <u>23626</u> | <u>23647</u> | <u>23669</u> | <u>23690</u> | <u>23751</u> |
| \$9,626.24 | \$10,102.12 | \$11,314.01 | \$11,471.78 | \$12,281.62 | \$14,721.70 | \$26,131.39 | \$32,104.92 |

Pre-trimmed Pneumatic Release Praction Galvanized IPG V403

| 1-1/2" | 2" | 2-1/2" | 3" | 4" | 6" | 8" | 10" |
|--------------|--------------|--------------|--------------|--------------|--------------|--------------|--------------|
| <u>23566</u> | <u>23587</u> | <u>23608</u> | <u>23629</u> | <u>23651</u> | <u>23672</u> | <u>23693</u> | <u>23754</u> |
| \$9,626.25 | \$10,102.13 | \$11,314.02 | \$11,471.77 | \$12,281.62 | \$14,721.70 | \$26,131.39 | \$32,104.92 |

Pre-trimmed Electric/Pneumatic Release Praction Galvanized IPG V403

| 1-1/2" | 2" | 2-1/2" | 3" | 4" | 6" | 8" | 10" |
|--------------|--------------|--------------|--------------|--------------|--------------|--------------|--------------|
| <u>23569</u> | <u>23590</u> | <u>23611</u> | <u>23632</u> | <u>23654</u> | <u>23675</u> | <u>23696</u> | <u>23757</u> |
| \$10,495.82 | \$10,971.70 | \$12,183.59 | \$12,341.36 | \$13,151.20 | \$15,591.28 | \$27,000.97 | \$32,974.50 |

VXD Praction Systems - Loose Valve and Trim

Model VXD Deluge Valve - Groove/Groove IPG V400

| 1-1/2" | 2" | 2-1/2" | 3" | 4" | 6" | 8" | 10" |
|--------------|--------------|--------------|--------------|--------------|--------------|--------------|--------------|
| <u>23310</u> | <u>23311</u> | <u>23312</u> | <u>23313</u> | <u>23316</u> | <u>23319</u> | <u>23322</u> | <u>23325</u> |
| \$3,152.23 | \$3,554.41 | \$4,930.64 | \$5,113.00 | \$5,952.42 | \$7,821.95 | \$18,104.68 | \$23,454.10 |

Model VXD Deluge Valve - Flange/Flange IPG V400

| 3" | 4" | 6" | 8" | 10" |
|--------------|--------------|--------------|--------------|--------------|
| <u>23314</u> | <u>23317</u> | <u>23320</u> | <u>23323</u> | <u>23326</u> |
| \$5,113.00 | \$5,952.42 | \$7,821.95 | \$18,104.68 | \$23,454.10 |

Loose Trim Electric Release Praction Galvanized IPG V401

| 1-1/2" | 2" | 2-1/2" | 3" | 4" | 6" | 8" | 10" |
|----------------|----------------|----------------|----------------|----------------|----------------|----------------|----------------|
| <u>23562-1</u> | <u>23583-1</u> | <u>23604-1</u> | <u>23625-1</u> | <u>23646-1</u> | <u>23668-1</u> | <u>23689-1</u> | <u>23750-1</u> |
| \$4,908.50 | \$4,908.50 | \$4,917.05 | \$4,917.05 | \$4,998.09 | \$5,004.15 | \$6,723.76 | \$7,140.89 |

Loose Trim Pneumatic Release Praction Galvanized IPG V401

| 1-1/2" | 2" | 2-1/2" | 3" | 4" | 6" | 8" | 10" |
|----------------|----------------|----------------|----------------|----------------|----------------|----------------|----------------|
| <u>23565-1</u> | <u>23586-1</u> | <u>23607-1</u> | <u>23628-1</u> | <u>23650-1</u> | <u>23671-1</u> | <u>23692-1</u> | <u>23753-1</u> |
| \$4,908.50 | \$4,908.50 | \$4,917.05 | \$4,917.05 | \$4,998.08 | \$5,004.15 | \$6,723.76 | \$7,140.89 |

Loose Trim Electric/Pneumatic Release Praction Galvanized IPG V401

| 1-1/2" | 2" | 2-1/2" | 3" | 4" | 6" | 8" | 10" |
|----------------|----------------|----------------|----------------|----------------|----------------|----------------|----------------|
| <u>23568-1</u> | <u>23589-1</u> | <u>23610-1</u> | <u>23631-1</u> | <u>23653-1</u> | <u>23674-1</u> | <u>23695-1</u> | <u>23756-1</u> |
| \$5,570.24 | \$5,570.24 | \$5,662.61 | \$5,662.61 | \$5,836.54 | \$5,865.79 | \$7,385.51 | \$8,320.72 |

Riser Check Valve and Trim IPG V259/V220

| 1-1/2" | 2" | 2-1/2" | 3" | 4" | 6" | 8" | 10" |
|--------------|--------------|--------------|--------------|--------------|--------------|--------------|--------------|
| <u>11054</u> | <u>11059</u> | <u>07929</u> | <u>08507</u> | <u>08510</u> | <u>08513</u> | <u>08516</u> | <u>23788</u> |
| \$943.43 | \$1,090.78 | \$1,130.04 | \$1,130.04 | \$1,130.04 | \$2,091.24 | \$2,961.50 | \$4,300.12 |

Preaction System - Single Interlocked - Pneumatic Release

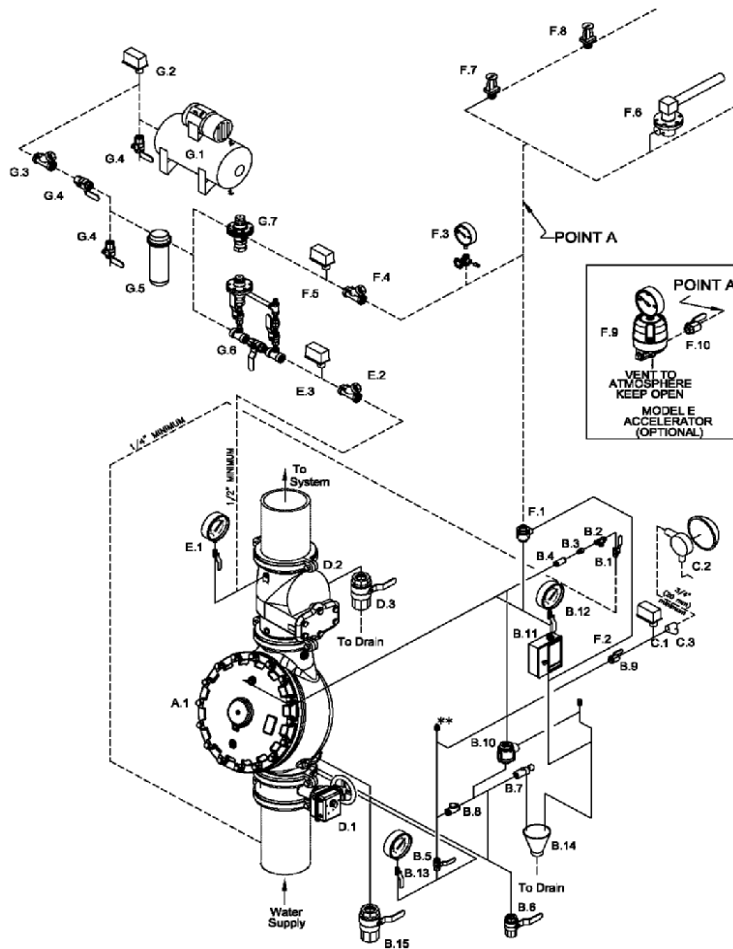

SYSTEM COMPONENTS

- A. Valve
 - A.1 Deluge Valve
- B. Deluge Valve Conventional Trim *
 - (See Deluge Valve Conventional Trim Charts)
 - B.1 Priming Valve (Normally Open)
 - B.2 Strainer
 - B.3 1/16" Restricted Orifice
 - B.4 Spring Loaded Check Valve
 - B.5 Alarm Test Valve (Normally Closed)
 - B.6 Auxiliary Drain Valve (Normally Closed)
 - B.7 Drip Check Valve
 - B.8 Drain Check Valve
 - B.9 Alarm Shut-Off Valve (Normally Open)
 - B.10 Pressure Operated Relief Valve (P.O.R.V.)
 - B.11 Emergency Release
 - B.12 Priming Pressure Water Gauge and Valve
 - B.13 Water Supply Pressure Gauge and Valve
 - B.14 Drain Cup
 - B.15 Flow Test Valve (Normally Closed)
- C. Water Flow Alarm Equipment
 - C.1 Alarm Pressure Switch and/or
 - C.2 Water Motor Alarm (Strainer Required)
 - C.3 Strainer
- D. Riser
 - D.1 Water Supply Control Valve
 - D.2 Easy Riser Check Valve or rubber seated check valve
 - D.3 Sprinkler System Main Drain
- E. Supervisory Air Supply
 - E.1 System Pressure Gauge and Valve
 - E.2 Soft Seat Swing Check Valve
 - E.3 Air Pressure Supervisory Switch
- F. Release System
 - F.1 Pneumatic Actuator
 - F.2 Pneumatic Release Module Trim
 - F.3 Air Pressure Gauge and Valve
 - F.4 Soft Seat Check Valve
 - F.5 Air Pressure Supervisory Switch
 - F.6 Thermostatic Release and/or
 - F.7 Fixed Temperature Release and/or
 - F.8 Pilot Head (Sprinkler)
 - F.9 Accelerator (Optional. See Inset.)
 - F.10 Accelerator Isolation Valve (See Inset.)
- G. Air Supply
 - G.1 Automatic Air Supply, Air Compressor and Tank shown for clarity.
 - G.2 Air Supervisory Pressure Switch (Compressor On/Off Control Switch)
 - G.3 Soft Seat Check Valve
 - G.4 Shut Off Valve (Indicating Ball Valve recommended.)
 - G.5 Dehydrator
 - G.6 Air maintenance Device & By-Pass Trim
 - G.7 Air maintenance Device

Straight-through valve shown. Components above are included in Quik Pik packages as customized by user.

Model F Deluge / Preaction Valve* - STRAIGHT THROUGH

| V233 | 1-1/2" | 2" | 2-1/2" | 3" | 4" | 6" | 8" |
|-----------------|----------------------------|----------------------------|----------------------------|----------------------------|----------------------------|----------------------------|-----------------------------|
| Thread X Thread | <u>12126</u> \$4,027.62 | <u>12059</u> \$4,162.89 | <u>12401</u> \$5,497.16 | N/A | N/A | N/A | N/A |
| Flange X Flange | N/A | N/A | N/A | <u>12014</u> \$5,497.16 | <u>11953</u> \$7,160.55 | <u>11955</u> \$9,794.34 | <u>11991</u> \$22,185.37 |
| Flange X Groove | N/A | N/A | N/A | <u>12018</u> \$5,497.16 | <u>11952</u> \$7,160.55 | <u>11954</u> \$9,794.34 | N/A |
| Groove X Groove | <u>12125</u> \$4,027.62 | <u>12057</u> \$4,162.89 | <u>12403</u> \$5,497.16 | <u>12022</u> \$5,497.16 | <u>11513</u> \$7,160.55 | <u>11524</u> \$9,794.34 | <u>11018</u> \$22,185.37 |

See page O-19-20 for additional valve and trim options, including Halar® coated valves, horizontal trim, domestic trim, and brass trim packages.

* Valve is not included in trim packages. Please order separately. See following page for trim packages and equipment.

Preaction System - Single Interlocked - Pneumatic Release

| TrimPac® V251 | 1-1/2" | 2" | 2-1/2" | 3" | 4" | 6" | 8" |
|------------------|-----------------|-----------------|-----------------|-----------------|-----------------|-----------------|-----------------|
| Straight-Through | <u>13793B-4</u> | <u>13793B-4</u> | <u>13793B-4</u> | <u>13793B-4</u> | <u>13793B-4</u> | <u>13793B-4</u> | <u>13793B-4</u> |
| | \$7,023.02 | \$7,023.02 | \$7,023.02 | \$7,023.02 | \$7,023.02 | \$7,023.02 | \$7,023.02 |

TrimPac® includes conventional trim, releasing device (pneumatic actuator), releasing trim, and flexible hose kit.

Drain package for TrimPac® must be ordered separately (see below).

Drain Package (IPG V257)

| Use with TrimPac® (order separately) | 11894-1 | 11894-2 | 11894-3 | 11894-3 | 11894-4 | 11894-4 | 11894-4 |
|---|----------|----------|----------|----------|----------|----------|----------|
| | \$738.33 | \$597.20 | \$676.78 | \$676.78 | \$868.61 | \$868.61 | \$868.61 |

| 1-1/2" | 2" | 2-1/2" | 3" | 4" | 6" | 8" |
|--------|----|--------|----|----|----|----|
|--------|----|--------|----|----|----|----|

Trim (Vertical - Straight Through Valve) - Galvanized (IPG 236)

| | | | | | | | |
|---|-----------------|-----------------|-----------------|-----------------|-----------------|-----------------|-----------------|
| Loose Trim (incl. accessory pkg-09316) | <u>14634-1</u> | <u>14634-1</u> | <u>14636-1</u> | <u>14636-1</u> | <u>14639-1</u> | <u>14641-1</u> | <u>14642-1</u> |
| | \$4,488.91 | \$4,488.91 | \$4,392.98 | \$4,392.98 | \$4,596.80 | \$4,607.59 | \$6,674.29 |
| Modular Trim (incl. accessory pkg-09316) | <u>14634-1P</u> | <u>14634-1P</u> | <u>14636-1P</u> | <u>14636-1P</u> | <u>14639-1P</u> | <u>14641-1P</u> | <u>14642-1P</u> |
| | \$4,894.21 | \$4,894.21 | \$4,798.23 | \$4,798.23 | \$5,003.98 | \$5,014.73 | \$7,081.44 |

| 1-1/2" | 2" | 2-1/2" | 3" | 4" | 6" | 8" |
|--------|----|--------|----|----|----|----|
|--------|----|--------|----|----|----|----|

Releasing Devices (IPG V226)

| | | | | | | | |
|--------------------|---------------|---------------|---------------|---------------|---------------|---------------|---------------|
| Pneumatic Actuator | <u>06459B</u> | <u>06459B</u> | <u>06459B</u> | <u>06459B</u> | <u>06459B</u> | <u>06459B</u> | <u>06459B</u> |
| | \$866.99 | \$866.99 | \$866.99 | \$866.99 | \$866.99 | \$866.99 | \$866.99 |

Releasing Trim - Galvanized (IPG V238)

| | | | | | | | |
|--|-----------------|-----------------|-----------------|-----------------|-----------------|-----------------|-----------------|
| Loose Trim (releasing device not incl.) | <u>10809</u> | <u>10809</u> | <u>10809</u> | <u>10809</u> | <u>10809</u> | <u>10809</u> | <u>10809</u> |
| | \$135.84 | \$135.84 | \$135.84 | \$135.84 | \$135.84 | \$135.84 | \$135.84 |
| Modular Trim (releasing device not incl.) | <u>10809P</u> | <u>10809P</u> | <u>10809P</u> | <u>10809P</u> | <u>10809P</u> | <u>10809P</u> | <u>10809P</u> |
| | \$605.38 | \$605.38 | \$605.38 | \$605.38 | \$605.38 | \$605.38 | \$605.38 |
| Loose Trim-DOMESTIC ¹ (releasing device not incl.) | <u>10809USA</u> | <u>10809USA</u> | <u>10809USA</u> | <u>10809USA</u> | <u>10809USA</u> | <u>10809USA</u> | <u>10809USA</u> |
| | \$181.12 | \$181.12 | \$181.12 | \$181.12 | \$181.12 | \$181.12 | \$181.12 |

| 1-1/2" | 2" | 2-1/2" | 3" | 4" | 6" | 8" |
|--------|----|--------|----|----|----|----|
|--------|----|--------|----|----|----|----|

Riser Check Valve and Trim (IPG V259 / V222)

| | | | | | | | |
|---|--------------|--------------|--------------|--------------|--------------|--------------|--------------|
| Riser Check Valve Threaded | <u>10659</u> | <u>10667</u> | N/A | N/A | N/A | N/A | N/A |
| | \$943.43 | \$1,090.78 | | | | | |
| Riser Check Valve Flange / Flange | N/A | N/A | N/A | <u>08505</u> | <u>08508</u> | <u>08511</u> | N/A |
| | | | | \$1,567.34 | \$1,614.94 | \$2,662.74 | |
| Riser Check Valve Flange / Groove | N/A | N/A | N/A | <u>08506</u> | <u>08509</u> | <u>08512</u> | <u>08515</u> |
| | | | | \$1,329.27 | \$1,368.22 | \$2,264.37 | \$3,205.01 |
| Riser Check Valve Groove / Groove | <u>11054</u> | <u>11059</u> | <u>07929</u> | <u>08507</u> | <u>08510</u> | <u>08513</u> | <u>08516</u> |
| | \$943.43 | \$1,090.78 | \$1,130.04 | \$1,130.04 | \$1,130.04 | \$2,091.24 | \$2,961.50 |
| Riser Check Valve Trim (For Preaction) | <u>12960</u> | <u>12960</u> | <u>13776</u> | <u>13776</u> | <u>13777</u> | <u>13777</u> | <u>13777</u> |
| | \$319.07 | \$319.07 | \$799.33 | \$799.33 | \$844.96 | \$844.96 | \$844.96 |

Riser check valve trim includes system main drain valve and air pressure gauge.

Please contact your customer service center for price and availability of non-interlocked preaction systems.

Preaction System - Single Interlocked - Electric Release

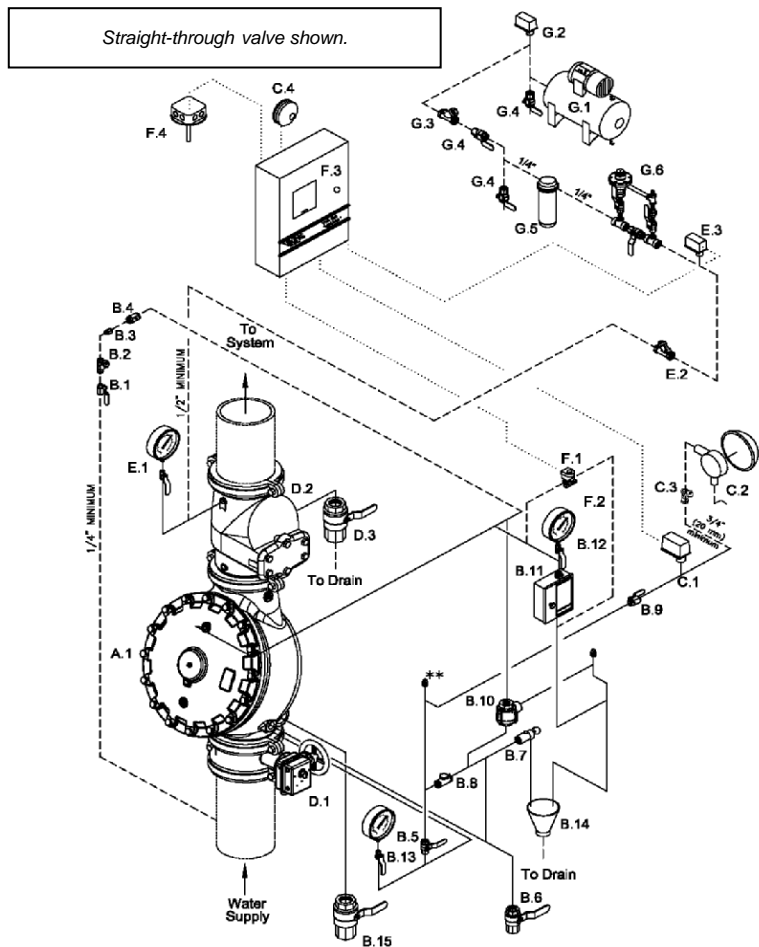

----- Dashed lines indicate pipe required but not listed in "System Components" Table.
 Dotted lines indicate electrical detection system wiring required but not listed in "System Components" Table. For additional wiring requirements refer to technical data for components used.

SYSTEM COMPONENTS

- A. Valve
 - A.1 Deluge Valve
 - B. Deluge Valve Conventional Trim *
 - (See Deluge Valve Conventional Trim Charts)
 - B.1 Priming Valve (Normally Open)
 - B.2 Strainer
 - B.3 1/16" Restricted Orifice
 - B.4 Spring Loaded Check Valve
 - B.5 Alarm Test Valve (Normally Closed)
 - B.6 Auxiliary Drain Valve (Normally Closed)
 - B.7 Drip Check Valve
 - B.8 Drain Check Valve
 - B.9 Alarm Shut-Off Valve (Normally Open)
 - B.10 Pressure Operated Relief Valve (P.O.R.V.)
 - B.11 Emergency Release
 - B.12 Priming Pressure Water Gauge and Valve
 - B.13 Water Supply Pressure Gauge and Valve
 - B.14 Drain Cup
 - B.15 Flow Test Valve (Normally Closed)
 - C. Water Flow Alarm Equipment
 - C.1 Alarm Pressure Switch and/or
 - C.2 Water Molor Alarm (Strainer Required)
 - C.3 Strainer
 - C.4 Electric Alarm Bell
 - D. Riser
 - D.1 Water Supply Control Valve
 - D.2 Easy Riser Check Valve or rubber seated check valve
 - D.3 Sprinkler System Main Drain
 - E. Supervisory Air Supply
 - E.1 System Pressure Gauge and Valve
 - E.2 Soft Seat Swing Check Valve
 - E.3 Air Pressure Supervisory Switch
 - F. Release System
 - F.1 Solenoid Valve (Normally Closed)
 - F.2 Electric Release Trim
 - F.3 System Control Panel configured for Non-Interlocked Preaction operation.
 - F.4 Electric Detection System. Heat Detector shown for clarity.
-
- G.1 Automatic Air Supply. Air Compressor and Tank shown for clarity.
 - G.2 Air Supervisory Pressure Switch (Compressor On/Off Control Switch)
 - G.3 Soft Seat Check Valve
 - G.4 Shut Off Valve (Indicating Ball Valve recommended.)
 - G.5 Dehydrator
 - G.6 Air maintenance Device & By-Pass Trim
 - G.7 1/2 x 1/4" Reducing Coupling

Components shown above are included in Quik Pik packages as customized by user. See page O-5.

Model F Deluge / Preaction Valve* - STRAIGHT THROUGH

| V233 | 1-1/2" | 2" | 2-1/2" | 3" | 4" | 6" | 8" |
|-----------------|----------------------------|----------------------------|----------------------------|----------------------------|----------------------------|----------------------------|-----------------------------|
| Thread X Thread | <u>12126</u> \$4,027.62 | <u>12059</u> \$4,162.89 | <u>12401</u> \$5,497.16 | N/A | N/A | N/A | N/A |
| Flange X Flange | N/A | N/A | N/A | <u>12014</u> \$5,497.16 | <u>11953</u> \$7,160.55 | <u>11955</u> \$9,794.34 | <u>11991</u> \$22,185.37 |
| Flange X Groove | N/A | N/A | N/A | <u>12018</u> \$5,497.16 | <u>11952</u> \$7,160.55 | <u>11954</u> \$9,794.34 | N/A |
| Groove X Groove | <u>12125</u> \$4,027.62 | <u>12057</u> \$4,162.89 | <u>12403</u> \$5,497.16 | <u>12022</u> \$5,497.16 | <u>11513</u> \$7,160.55 | <u>11524</u> \$9,794.34 | <u>11018</u> \$22,185.37 |

See page O-19-20 for additional valve and trim options, including Halar® coated valves, horizontal trim, domestic trim, and brass trim packages.

* Valve is not included in trim packages. Please order separately. See following page for trim packages and equipment.

Preaction System - Single Interlocked - Electric Release

| TrimPac® | V234 | 1-1/2" | 2" | 2-1/2" | 3" | 4" | 6" | 8" |
|------------------|------|------------|------------|------------|------------|------------|------------|------------|
| Straight-Through | | 13792B-3 | 13792B-3 | 13792B-3 | 13792B-3 | 13792B-3 | 13792B-3 | 13792B-3 |
| | | \$7,152.00 | \$7,152.00 | \$7,152.00 | \$7,152.00 | \$7,152.00 | \$7,152.00 | \$7,152.00 |

TrimPac® includes conventional trim, releasing device (solenoid valve), releasing trim, and flexible hose kit.

Drain package for TrimPac® must be ordered separately (see below).

Drain Package (IPG V257)

| Use with TrimPac® | 11894-1 | 11894-2 | 11894-3 | 11894-3 | 11894-4 | 11894-4 | 11894-4 |
|--------------------|----------|----------|----------|----------|----------|----------|----------|
| (order separately) | \$738.33 | \$597.20 | \$676.78 | \$676.78 | \$868.61 | \$868.61 | \$868.61 |

| 1-1/2" | 2" | 2-1/2" | 3" | 4" | 6" | 8" |
|--------|----|--------|----|----|----|----|
|--------|----|--------|----|----|----|----|

Trim (Vertical - Straight Through Valve) - Galvanized (IPG V236)

| | | | | | | | |
|--|------------|------------|------------|------------|------------|------------|------------|
| Loose Trim <i>(incl. accessory pkg-09316)</i> | 14634-1 | 14634-1 | 14636-1 | 14636-1 | 14639-1 | 14641-1 | 14642-1 |
| | \$4,488.91 | \$4,488.91 | \$4,392.98 | \$4,392.98 | \$4,596.80 | \$4,607.59 | \$6,674.29 |
| Modular Trim <i>(incl. accessory pkg-09316)</i> | 14634-1P | 14634-1P | 14636-1P | 14636-1P | 14639-1P | 14641-1P | 14642-1P |
| | \$4,894.21 | \$4,894.21 | \$4,798.23 | \$4,798.23 | \$5,003.98 | \$5,014.73 | \$7,081.44 |

| 1-1/2" | 2" | 2-1/2" | 3" | 4" | 6" | 8" |
|--------|----|--------|----|----|----|----|
|--------|----|--------|----|----|----|----|

Releasing Devices (IPG V240)

| | | | | | | | |
|----------------|------------|------------|------------|------------|------------|------------|------------|
| Solenoid Valve | 11601 | 11601 | 11601 | 11601 | 11601 | 11601 | 11601 |
| | \$1,345.64 | \$1,345.64 | \$1,345.64 | \$1,345.64 | \$1,345.64 | \$1,345.64 | \$1,345.64 |

Releasing Trim - Galvanized (IPG V238)

| | | | | | | | |
|--|----------|----------|----------|----------|----------|----------|----------|
| Loose Trim <i>(releasing device not incl.)</i> | 10830 | 10830 | 10830 | 10830 | 10830 | 10830 | 10830 |
| | \$140.24 | \$140.24 | \$140.24 | \$140.24 | \$140.24 | \$140.24 | \$140.24 |
| Modular Trim <i>(releasing device not incl.)</i> | 10830P | 10830P | 10830P | 10830P | 10830P | 10830P | 10830P |
| | \$605.38 | \$605.38 | \$605.38 | \$605.38 | \$605.38 | \$605.38 | \$605.38 |
| Loose Trim - DOMESTIC <i>(releasing device not incl.)</i> | 10830USA | 10830USA | 10830USA | 10830USA | 10830USA | 10830USA | 10830USA |
| | \$186.96 | \$186.96 | \$186.96 | \$186.96 | \$186.96 | \$186.96 | \$186.96 |

| 1-1/2" | 2" | 2-1/2" | 3" | 4" | 6" | 8" |
|--------|----|--------|----|----|----|----|
|--------|----|--------|----|----|----|----|

Riser Check Valve and Trim (IPG V259 / V222)

| | | | | | | | |
|--|----------|------------|------------|------------|------------|------------|------------|
| Riser Check Valve Threaded | 10659 | 10667 | N/A | N/A | N/A | N/A | N/A |
| | \$943.43 | \$1,090.78 | | | | | |
| Riser Check Valve Flange / Flange | N/A | N/A | N/A | 08505 | 08508 | 08511 | N/A |
| | | | | \$1,567.34 | \$1,614.94 | \$2,662.74 | |
| Riser Check Valve Flange / Groove | N/A | N/A | N/A | 08506 | 08509 | 08512 | 08515 |
| | | | | \$1,329.27 | \$1,368.22 | \$2,264.37 | \$3,205.01 |
| Riser Check Valve Groove / Groove | 11054 | 11059 | 07929 | 08507 | 08510 | 08513 | 08516 |
| | \$943.43 | \$1,090.78 | \$1,130.04 | \$1,130.04 | \$1,130.04 | \$2,091.24 | \$2,961.50 |
| Riser Check Valve Trim <i>(For Preaction)</i> | 12960 | 12960 | 13776 | 13776 | 13777 | 13777 | 13777 |
| | \$319.07 | \$319.07 | \$799.33 | \$799.33 | \$844.96 | \$844.96 | \$844.96 |

Riser check valve trim includes system main drain valve and air pressure gauge.

Please contact your customer service center for price and availability of non-interlocked preaction systems.

Precision System - Double Interlocked - Pneumatic/Pneumatic Release

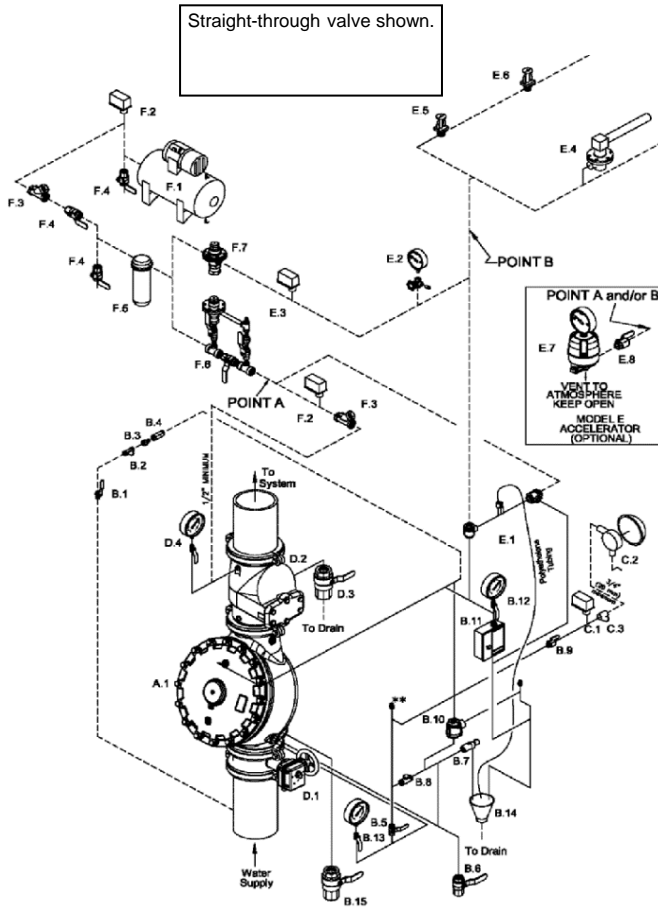

SYSTEM COMPONENTS

- A. Valve**
 - A.1 Deluge Valve
- B. Deluge Valve Conventional Trim ***
(See Deluge Valve Conventional Trim Charts)
 - B.1 Priming Valve (Normally Open)
 - B.2 Strainer
 - B.3 1/16" Restricted Orifice
 - B.4 Spring Loaded Check Valve
 - B.5 Alarm Test Valve (Normally Closed)
 - B.6 Auxiliary Drain Valve (Normally Closed)
 - B.7 Drip Check Valve
 - B.8 Drain Check Valve
 - B.9 Alarm Shut-Off Valve (Normally Open)
 - B.10 Pressure Operated Relief Valve (P.O.R.V.)
 - B.11 Emergency Release
 - B.12 Priming Pressure Water Gauge and Valve
 - B.13 Water Supply Pressure Gauge and Valve
 - B.14 Drain Cup
 - B.15 Flow Test Valve (Normally Closed)
- C. Water Flow Alarm Equipment**
 - C.1 Alarm Pressure Switch and/or
 - C.2 Water Motor Alarm (Strainer Required)
 - C.3 Strainer
- D. Riser**
 - D.1 Water Supply Control Valve
 - D.2 Easy Riser Check Valve or rubber seated check valve
 - D.3 Sprinkler System Main Drain
 - D.4 System Pressure Gauge and Valve
- E. Release System**
 - E.1 Pneumatic/Pneumatic Release Module Trim
 - E.2 Air Pressure Gauge and Valve
 - E.3 Air Pressure Supervisory Switch
 - E.4 Thermostatic Release and/or
 - E.5 Fixed Temperature Release and/or
 - E.6 Pilot Head (Sprinkler)
 - E.7 Accelerator (Optional. See Inset.)
 - E.8 Accelerator Isolation Valve (See Inset.)
- F. Air Supply**
 - F.1 Tank Mounted Air Compressor
 - F.2 Air Supervisory Pressure Switch (Compressor On/Off Control Switch)
 - F.3 Soft Seat Check Valve
 - F.4 Shut Off Valve (Indicating Ball Valve recommended.)
 - F.5 Dehydrator
 - F.6 Air maintenance Device & By-Pass Trim
 - F.7 Air maintenance Device
 - F.8 Air Pressure Supervisory Switch
 - F.9 Soft Seat Swing Check Valve

----- Dashed lines indicate pipe required but not included with Deluge Valve Conventional Trim and Easy Riser Check Valve Trim Packages.

* Viking Deluge Valve Trim Packages contain items B.1 through B.15 and associated nipples. Viking Accessory Package for Conventional Deluge Valve Trim contains B.2 through B.5, B.7 through B.11, and B.14.

Model F Deluge / Precision Valve* - STRAIGHT THROUGH

| V233 | 1-1/2" | 2" | 2-1/2" | 3" | 4" | 6" | 8" |
|-----------------|----------------------------|----------------------------|----------------------------|----------------------------|----------------------------|----------------------------|-----------------------------|
| Thread X Thread | <u>12126</u> \$4,027.62 | <u>12059</u> \$4,162.89 | <u>12401</u> \$5,497.16 | N/A | N/A | N/A | N/A |
| Flange X Flange | N/A | N/A | N/A | <u>12014</u> \$5,497.16 | <u>11953</u> \$7,160.55 | <u>11955</u> \$9,794.34 | <u>11991</u> \$22,185.37 |
| Flange X Groove | N/A | N/A | N/A | <u>12018</u> \$5,497.16 | <u>11952</u> \$7,160.55 | <u>11954</u> \$9,794.34 | N/A |
| Groove X Groove | <u>12125</u> \$4,027.62 | <u>12057</u> \$4,162.89 | <u>12403</u> \$5,497.16 | <u>12022</u> \$5,497.16 | <u>11513</u> \$7,160.55 | <u>11524</u> \$9,794.34 | <u>11018</u> \$22,185.37 |

See page O-19-20 for additional valve and trim options, including Halar® coated valves, horizontal trim, domestic trim, and brass trim packages.

* Valve is not included in trim packages. Please order separately. See following page for trim packages and equipment.

Preaction System - Double Interlocked - Pneumatic/Pneumatic Release

| 1-1/2" | 2" | 2-1/2" | 3" | 4" | 6" | 8" |
|--------|----|--------|----|----|----|----|
|--------|----|--------|----|----|----|----|

Trim (Vertical - Straight Through Valve) - Galvanized (IPG V236)

| | 1-1/2" | 2" | 2-1/2" | 3" | 4" | 6" | 8" |
|---|-------------------------------|-------------------------------|-------------------------------|-------------------------------|-------------------------------|-------------------------------|-------------------------------|
| <u>Loose Trim</u> <i>(incl. accessory pkg-09316)</i> | <u>14634-1</u> \$4,488.91 | <u>14634-1</u> \$4,488.91 | <u>14636-1</u> \$4,392.98 | <u>14636-1</u> \$4,392.98 | <u>14639-1</u> \$4,596.80 | <u>14641-1</u> \$4,607.59 | <u>14642-1</u> \$6,674.29 |
| <u>Modular Trim</u> <i>(incl. accessory pkg-09316)</i> | <u>14634-1P</u> \$4,894.21 | <u>14634-1P</u> \$4,894.21 | <u>14636-1P</u> \$4,798.23 | <u>14636-1P</u> \$4,798.23 | <u>14639-1P</u> \$5,003.98 | <u>14641-1P</u> \$5,014.73 | <u>14642-1P</u> \$7,081.44 |

| 1-1/2" | 2" | 2-1/2" | 3" | 4" | 6" | 8" |
|--------|----|--------|----|----|----|----|
|--------|----|--------|----|----|----|----|

Releasing Devices (IPG V226)

| | 1-1/2" | 2" | 2-1/2" | 3" | 4" | 6" | 8" |
|---------------------------|---------------------------|---------------------------|---------------------------|---------------------------|---------------------------|---------------------------|---------------------------|
| <u>Pneumatic Actuator</u> | <u>06459B</u> \$866.99 | <u>06459B</u> \$866.99 | <u>06459B</u> \$866.99 | <u>06459B</u> \$866.99 | <u>06459B</u> \$866.99 | <u>06459B</u> \$866.99 | <u>06459B</u> \$866.99 |

On pneumatic/pneumatic preaction systems only, releasing devices (pneumatic actuators) are included in releasing trim.

Releasing Trim - Galvanized (IPG V238)

| | 1-1/2" | 2" | 2-1/2" | 3" | 4" | 6" | 8" |
|---------------------|------------------------------|------------------------------|------------------------------|------------------------------|------------------------------|------------------------------|------------------------------|
| <u>Loose Trim</u> | <u>12662-1</u> \$2,334.33 | <u>12662-1</u> \$2,334.33 | <u>12662-1</u> \$2,334.33 | <u>12662-1</u> \$2,334.33 | <u>12662-1</u> \$2,334.33 | <u>12662-1</u> \$2,334.33 | <u>12662-1</u> \$2,334.33 |
| <u>Modular Trim</u> | <u>12662-1P</u> P.O.A. | <u>12662-1P</u> P.O.A. | <u>12662-1P</u> P.O.A. | <u>12662-1P</u> P.O.A. | <u>12662-1P</u> P.O.A. | <u>12662-1P</u> P.O.A. | <u>12662-1P</u> P.O.A. |

On pneumatic/pneumatic preaction systems only, releasing devices (pneumatic actuators) are included in releasing trim.

| 1-1/2" | 2" | 2-1/2" | 3" | 4" | 6" | 8" |
|--------|----|--------|----|----|----|----|
|--------|----|--------|----|----|----|----|

Riser Check Valve and Trim (IPG V259 / V222)

| | 1-1/2" | 2" | 2-1/2" | 3" | 4" | 6" | 8" |
|---|--------------------------|----------------------------|----------------------------|----------------------------|----------------------------|----------------------------|----------------------------|
| <u>Riser Check Valve</u> Threaded | <u>10659</u> \$943.43 | <u>10667</u> \$1,090.78 | N/A | N/A | N/A | N/A | N/A |
| <u>Riser Check Valve</u> Flange / Flange | N/A | N/A | N/A | <u>08505</u> \$1,567.34 | <u>08508</u> \$1,614.94 | <u>08511</u> \$2,662.74 | N/A |
| <u>Riser Check Valve</u> Flange / Groove | N/A | N/A | N/A | <u>08506</u> \$1,329.27 | <u>08509</u> \$1,368.22 | <u>08512</u> \$2,264.37 | <u>08515</u> \$3,205.01 |
| <u>Riser Check Valve</u> Groove / Groove | <u>11054</u> \$943.43 | <u>11059</u> \$1,090.78 | <u>07929</u> \$1,130.04 | <u>08507</u> \$1,130.04 | <u>08510</u> \$1,130.04 | <u>08513</u> \$2,091.24 | <u>08516</u> \$2,961.50 |
| <u>Riser Check Valve Trim</u> <i>(For Preaction)</i> | <u>12960</u> \$319.07 | <u>12960</u> \$319.07 | <u>13776</u> \$799.33 | <u>13776</u> \$799.33 | <u>13777</u> \$844.96 | <u>13777</u> \$844.96 | <u>13777</u> \$844.96 |

Riser check valve trim includes system main drain valve and air pressure gauge.

Preaction System - Double Interlocked - Electric/Pneumatic Release

Straight-through valve shown.

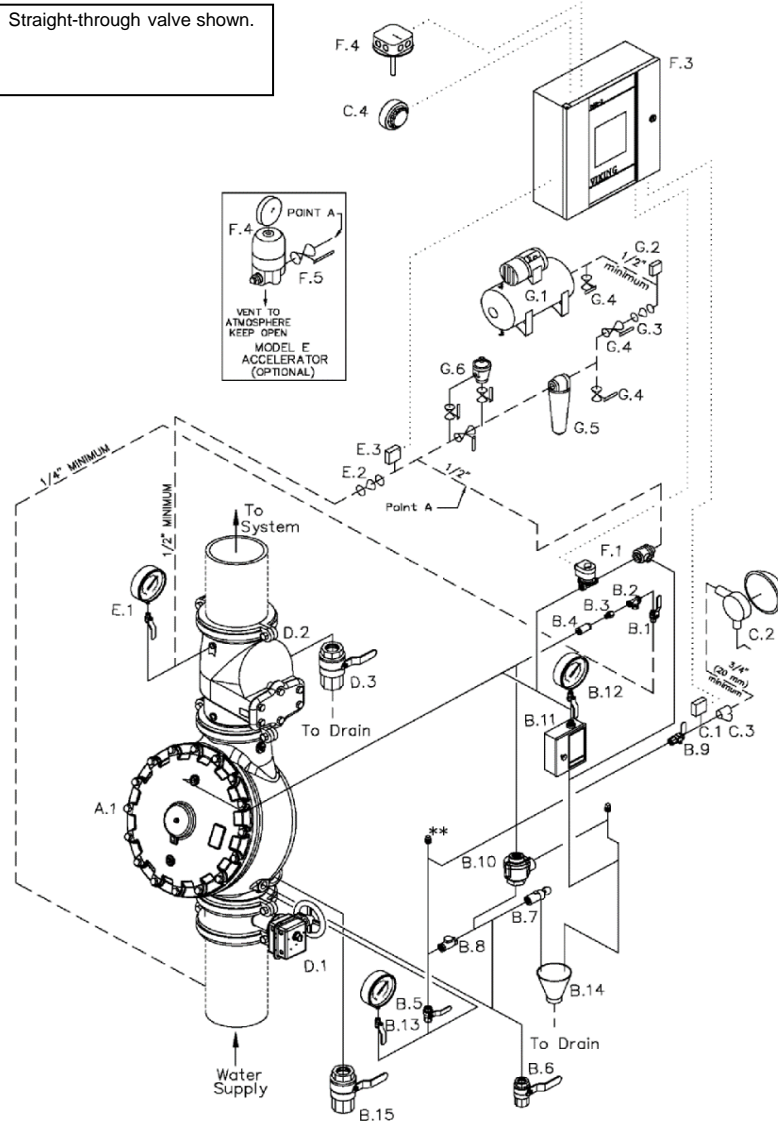

Description

- A.1 Model F deluge valve
Deluge valve conventional trim including:
- B.1 Priming connection ball valve (N.O.)
- B.2 Y strainer
- B.3 Restricted orifice
- B.4 Spring loaded in-line check valve
- B.5 Alarm test valve (normally closed)
- B.6 Auxiliary drain valve (normally closed)
- B.7 Drip check valve
- B.8 Drain check valve
- B.9 Alarm shut-off valve (normally open)
- B.10 Pressure operated relief valve (porv)
- B.11 Model C emergency release
- B.12 Priming pressure water gauge & valve
- B.13 Water supply pressure gauge & valve
- B.14 Drain cup
- B.15 Flow test valve (normally closed)
- C.1 Alarm pressure switch and/or
- C.2 Model F-2 water motor alarm including:
C.3 3/4" / DN20 alarm line Y strainer
- C.4 Electric alarm bell
- D.1 Water supply control valve
- D.2 Easy Riser® check valve & trim including:
D.3 System main drain valve
- E.1 Air pressure gauge and valve
- E.2 Soft seat air supply check valve
- E.3 Air pressure supervisory switch
- F.1 Electric/pneumatic release module trim
- F.1 Solenoid valve (normally closed)
- F.1 Pneumatic actuator
- F.3 VFR500 release control panel
- F.4 Electric detection system
- F.4 Model E-1 accelerator (optional)
- F.5 Accelerator isolation ball valve
- G.1 Automatic air supply
- G.2 Air pressure supervisory switch
- G.3 Soft seat air supply check valve
- G.4 Shut-off ball valve
- G.5 Dehydrator package
- G.6 D-2 air maintenance device and by-pass trim

Components shown above are included in QuikPik packages as customized by user. See page O-9.

Model F Deluge / Preaction Valve* - STRAIGHT THROUGH

| V233 | 1-1/2" | 2" | 2-1/2" | 3" | 4" | 6" | 8" |
|-----------------|----------------------------|----------------------------|----------------------------|----------------------------|----------------------------|----------------------------|-----------------------------|
| Thread X Thread | <u>12126</u> \$4,027.62 | <u>12059</u> \$4,162.89 | <u>12401</u> \$5,497.16 | N/A | N/A | N/A | N/A |
| Flange X Flange | N/A | N/A | N/A | <u>12014</u> \$5,497.16 | <u>11953</u> \$7,160.55 | <u>11955</u> \$9,794.34 | <u>11991</u> \$22,185.37 |
| Flange X Groove | N/A | N/A | N/A | <u>12018</u> \$5,497.16 | <u>11952</u> \$7,160.55 | <u>11954</u> \$9,794.34 | N/A |
| Groove X Groove | <u>12125</u> \$4,027.62 | <u>12057</u> \$4,162.89 | <u>12403</u> \$5,497.16 | <u>12022</u> \$5,497.16 | <u>11513</u> \$7,160.55 | <u>11524</u> \$9,794.34 | <u>11018</u> \$22,185.37 |

* Valve is not included in trim packages. Please order separately. See following page for trim packages and equipment.

Praction System - Double Interlocked - Electric/Pneumatic Release

| TrimPac® | V234 | 1-1/2" | 2" | 2-1/2" | 3" | 4" | 6" | 8" |
|------------------|------|-----------------|-----------------|-----------------|-----------------|-----------------|-----------------|-----------------|
| Straight-Through | | <u>13794B-5</u> | <u>13794B-5</u> | <u>13794B-5</u> | <u>13794B-5</u> | <u>13794B-5</u> | <u>13794B-5</u> | <u>13794B-5</u> |
| | | \$8,406.30 | \$8,406.30 | \$8,406.30 | \$8,406.30 | \$8,406.30 | \$8,406.30 | \$8,406.30 |

TrimPac® includes conventional trim, releasing devices, releasing trim, and flexible hose kit.

Drain package for TrimPac® must be ordered separately (see below).

Drain Package (IPG V257)

| Use with TrimPac® (order separately) | 11894-1 | 11894-2 | 11894-3 | 11894-3 | 11894-4 | 11894-4 | 11894-4 |
|---|----------|----------|----------|----------|----------|----------|----------|
| | \$738.33 | \$597.20 | \$676.78 | \$676.78 | \$868.61 | \$868.61 | \$868.61 |

| 1-1/2" | 2" | 2-1/2" | 3" | 4" | 6" | 8" |
|--------|----|--------|----|----|----|----|
|--------|----|--------|----|----|----|----|

Trim (Vertical - Straight Through Valve) - Galvanized (IPG V236)

| | | | | | | | |
|---|-----------------|-----------------|-----------------|-----------------|-----------------|-----------------|-----------------|
| Loose Trim (incl. accessory pkg-09316) | <u>14634-1</u> | <u>14634-1</u> | <u>14636-1</u> | <u>14636-1</u> | <u>14639-1</u> | <u>14641-1</u> | <u>14642-1</u> |
| | \$4,488.91 | \$4,488.91 | \$4,392.98 | \$4,392.98 | \$4,596.80 | \$4,607.59 | \$6,674.29 |
| Modular Trim (incl. accessory pkg-09316) | <u>14634-1P</u> | <u>14634-1P</u> | <u>14636-1P</u> | <u>14636-1P</u> | <u>14639-1P</u> | <u>14641-1P</u> | <u>14642-1P</u> |
| | \$4,894.21 | \$4,894.21 | \$4,798.23 | \$4,798.23 | \$5,003.98 | \$5,014.73 | \$7,081.44 |

| 1-1/2" | 2" | 2-1/2" | 3" | 4" | 6" | 8" |
|--------|----|--------|----|----|----|----|
|--------|----|--------|----|----|----|----|

Releasing Devices

| | | | | | | | |
|--------------------------------|---------------|---------------|---------------|---------------|---------------|---------------|---------------|
| Solenoid Valve IPG V240 | <u>11601</u> | <u>11601</u> | <u>11601</u> | <u>11601</u> | <u>11601</u> | <u>11601</u> | <u>11601</u> |
| | \$1,345.64 | \$1,345.64 | \$1,345.64 | \$1,345.64 | \$1,345.64 | \$1,345.64 | \$1,345.64 |
| Pneumatic Actuator IPG V226 | <u>06459B</u> | <u>06459B</u> | <u>06459B</u> | <u>06459B</u> | <u>06459B</u> | <u>06459B</u> | <u>06459B</u> |
| | \$866.99 | \$866.99 | \$866.99 | \$866.99 | \$866.99 | \$866.99 | \$866.99 |

Releasing Trim - Galvanized (IPG V238)

| | | | | | | | |
|---|-------------------|-------------------|-------------------|-------------------|-------------------|-------------------|-------------------|
| Loose Trim (releasing device not incl.) | <u>12661-1</u> | <u>12661-1</u> | <u>12661-1</u> | <u>12661-1</u> | <u>12661-1</u> | <u>12661-1</u> | <u>12661-1</u> |
| | \$145.53 | \$145.53 | \$145.53 | \$145.53 | \$145.53 | \$145.53 | \$145.53 |
| Modular Trim (releasing device not incl.) | <u>12661-1P</u> | <u>12661-1P</u> | <u>12661-1P</u> | <u>12661-1P</u> | <u>12661-1P</u> | <u>12661-1P</u> | <u>12661-1P</u> |
| | \$581.16 | \$581.16 | \$581.16 | \$581.16 | \$581.16 | \$581.16 | \$581.16 |
| Loose Trim - DOMESTIC (releasing device not incl.) | <u>12661-1USA</u> | <u>12661-1USA</u> | <u>12661-1USA</u> | <u>12661-1USA</u> | <u>12661-1USA</u> | <u>12661-1USA</u> | <u>12661-1USA</u> |
| | \$194.04 | \$194.04 | \$194.04 | \$194.04 | \$194.04 | \$194.04 | \$194.04 |

| 1-1/2" | 2" | 2-1/2" | 3" | 4" | 6" | 8" |
|--------|----|--------|----|----|----|----|
|--------|----|--------|----|----|----|----|

Riser Check Valve and Trim (IPG V259 / V222)

| | | | | | | | |
|--|--------------|--------------|--------------|--------------|--------------|--------------|--------------|
| Riser Check Valve Threaded | <u>10659</u> | <u>10667</u> | N/A | N/A | N/A | N/A | N/A |
| | \$943.43 | \$1,090.78 | | | | | |
| Riser Check Valve Flange / Flange | N/A | N/A | N/A | <u>08505</u> | <u>08508</u> | <u>08511</u> | N/A |
| | | | | \$1,567.34 | \$1,614.94 | \$2,662.74 | |
| Riser Check Valve Flange / Groove | N/A | N/A | N/A | <u>08506</u> | <u>08509</u> | <u>08512</u> | <u>08515</u> |
| | | | | \$1,329.27 | \$1,368.22 | \$2,264.37 | \$3,205.01 |
| Riser Check Valve Groove / Groove | <u>11054</u> | <u>11059</u> | <u>07929</u> | <u>08507</u> | <u>08510</u> | <u>08513</u> | <u>08516</u> |
| | \$943.43 | \$1,090.78 | \$1,130.04 | \$1,130.04 | \$1,130.04 | \$2,091.24 | \$2,961.50 |
| Riser Check Valve Trim (For Praction) | <u>12960</u> | <u>12960</u> | <u>13776</u> | <u>13776</u> | <u>13777</u> | <u>13777</u> | <u>13777</u> |
| | \$319.07 | \$319.07 | \$799.33 | \$799.33 | \$844.96 | \$844.96 | \$844.96 |

Riser check valve trim includes system main drain valve and air pressure gauge.

Praction System - Double Interlocked - Electric/Pneumatic Release

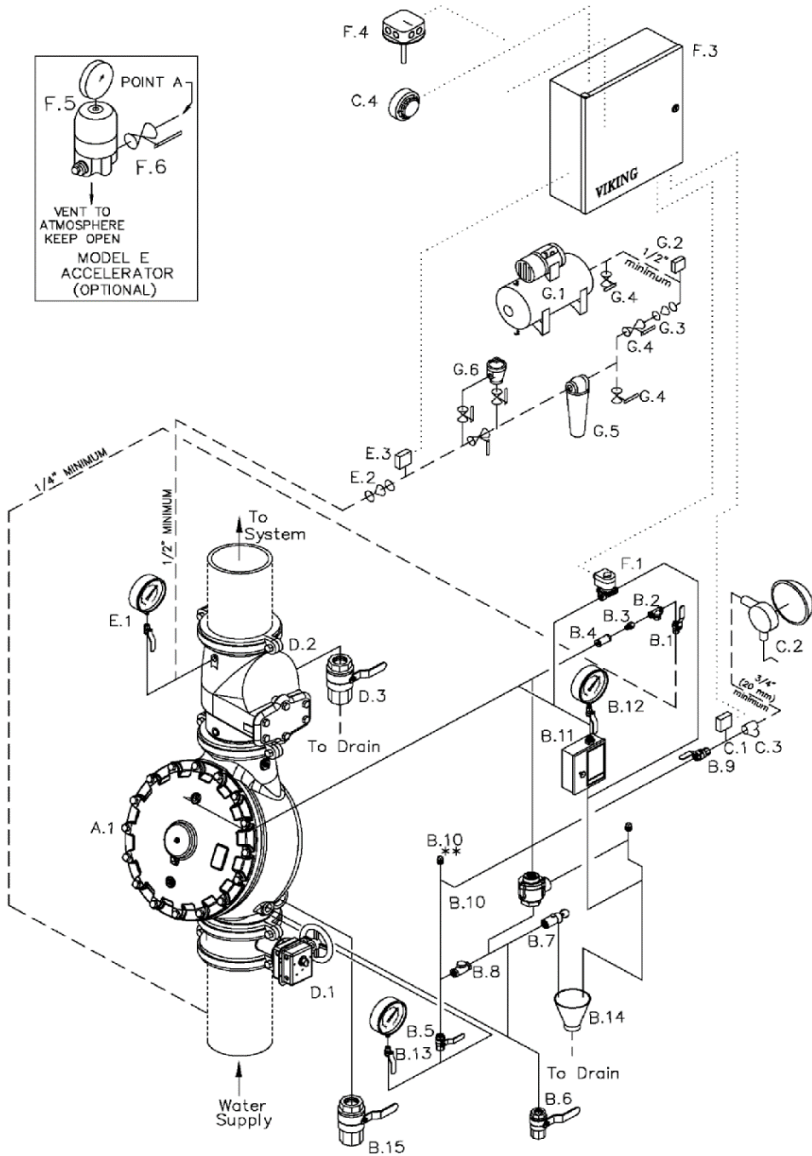

Description

- A.1 Deluge valve
Deluge valve conventional trim including:
- B.1 Priming connection ball valve (N.O.)
- B.2 Y strainer
- B.3 Restricted orifice
- B.4 Spring loaded in-line check valve
- B.5 Alarm test valve (normally closed)
- B.6 Auxiliary drain valve (normally closed)
- B.7 Drip check valve
- B.8 Drain check valve
- B.9 Alarm shut-off valve (normally open)
- B.10 Pressure operated relief valve (PORV)
- B.11 Model c emergency release
- B.12 Priming pressure water gauge & valve
- B.13 Water supply pressure gauge & valve
- B.14 Drain cup
- B.15 Flow test valve (normally closed)
- C.1 Alarm pressure switch and/or
- C.2 Model F-2 water motor alarm including:
- C.3 3/4" / DN20 alarm line Y strainer
- C.4 Electric alarm bell
- D.1 Water supply control valve
- D.2 Easy Riser® check valve
Easy Riser® trim for praction (including)
- D.3 System main drain valve
- E.1 Air pressure gauge and valve
- E.2 Soft seat air supply check valve
- E.3 Air pressure supervisory switch
- F.1 Solenoid valve (normally closed)
- F.2 Electric release module trim
- F.3 VFR-500 Release control panel
- F.4 Electric detection system
- F.5 Model E-1 accelerator (optional)
- F.6 Accelerator isolation ball valve
- G.1 Automatic air supply
- G.2 Air pressure supervisory switch
- G.3 Soft seat air supply check valve
- G.4 Shut-off ball valve
- G.5 Dehydrator package
- G.6 D-2 air maintenance device & by-pass trim

Components shown above are included in Quik Pik packages as customized by user. See page O-11.

Model F Deluge / Praction Valve* - STRAIGHT THROUGH

| V233 | 1-1/2" | 2" | 2-1/2" | 3" | 4" | 6" | 8" |
|-----------------|----------------------------|----------------------------|----------------------------|----------------------------|----------------------------|----------------------------|-----------------------------|
| Thread X Thread | <u>12126</u> \$4,027.62 | <u>12059</u> \$4,162.89 | <u>12401</u> \$5,497.16 | N/A | N/A | N/A | N/A |
| Flange X Flange | N/A | N/A | N/A | <u>12014</u> \$5,497.16 | <u>11953</u> \$7,160.55 | <u>11955</u> \$9,794.34 | <u>11991</u> \$22,185.37 |
| Flange X Groove | N/A | N/A | N/A | <u>12018</u> \$5,497.16 | <u>11952</u> \$7,160.55 | <u>11954</u> \$9,794.34 | N/A |
| Groove X Groove | <u>12125</u> \$4,027.62 | <u>12057</u> \$4,162.89 | <u>12403</u> \$5,497.16 | <u>12022</u> \$5,497.16 | <u>11513</u> \$7,160.55 | <u>11524</u> \$9,794.34 | <u>11018</u> \$22,185.37 |

See page O-19-20 for additional valve and trim options, including Halar® coated valves, horizontal trim, domestic trim, and brass trim packages.

* Valve is not included in trim packages. Please order separately. See following page for trim packages and equipment.

Preaction System - Double Interlocked - Electric/Pneu-lectric Release

| TrimPac® V234 | 1-1/2" | 2" | 2-1/2" | 3" | 4" | 6" | 8" |
|-------------------------|-----------------|-----------------|-----------------|-----------------|-----------------|-----------------|-----------------|
| <u>Straight-Through</u> | <u>13796B-6</u> | <u>13796B-6</u> | <u>13796B-6</u> | <u>13796B-6</u> | <u>13796B-6</u> | <u>13796B-6</u> | <u>13796B-6</u> |
| | \$7,152.00 | \$7,152.00 | \$7,152.00 | \$7,152.00 | \$7,152.00 | \$7,152.00 | \$7,152.00 |

TrimPac® includes conventional trim, releasing device (solenoid valve), releasing trim, and flexible hose kit.

Drain package for TrimPac® must be ordered separately (see below).

Drain Package (IPG V257)

| Use with TrimPac® (order separately) | 11894-1 | 11894-2 | 11894-3 | 11894-3 | 11894-4 | 11894-4 | 11894-4 |
|---|----------|----------|----------|----------|----------|----------|----------|
| | \$738.33 | \$597.20 | \$676.78 | \$676.78 | \$868.61 | \$868.61 | \$868.61 |

| 1-1/2" | 2" | 2-1/2" | 3" | 4" | 6" | 8" |
|--------|----|--------|----|----|----|----|
|--------|----|--------|----|----|----|----|

Trim (Vertical - Straight Through Valve) - Galvanized (IPG V236)

| | | | | | | | |
|--|-----------------|-----------------|-----------------|-----------------|-----------------|-----------------|-----------------|
| <u>Loose Trim</u> (incl. accessory pkg-09316) | <u>14634-1</u> | <u>14634-1</u> | <u>14636-1</u> | <u>14636-1</u> | <u>14639-1</u> | <u>14641-1</u> | <u>14642-1</u> |
| | \$4,488.91 | \$4,488.91 | \$4,392.98 | \$4,392.98 | \$4,596.80 | \$4,607.59 | \$6,674.29 |
| <u>Modular Trim</u> (incl. accessory pkg-09316) | <u>14634-1P</u> | <u>14634-1P</u> | <u>14636-1P</u> | <u>14636-1P</u> | <u>14639-1P</u> | <u>14641-1P</u> | <u>14642-1P</u> |
| | \$4,894.21 | \$4,894.21 | \$4,798.23 | \$4,798.23 | \$5,003.98 | \$5,014.73 | \$7,081.44 |

| 1-1/2" | 2" | 2-1/2" | 3" | 4" | 6" | 8" |
|--------|----|--------|----|----|----|----|
|--------|----|--------|----|----|----|----|

Releasing Devices (IPG V240)

| | | | | | | | |
|-----------------------|--------------|--------------|--------------|--------------|--------------|--------------|--------------|
| <u>Solenoid Valve</u> | <u>11601</u> | <u>11601</u> | <u>11601</u> | <u>11601</u> | <u>11601</u> | <u>11601</u> | <u>11601</u> |
| | \$1,345.64 | \$1,345.64 | \$1,345.64 | \$1,345.64 | \$1,345.64 | \$1,345.64 | \$1,345.64 |

Releasing Trim - Galvanized (IPG V238)

| | | | | | | | |
|--|-----------------|-----------------|-----------------|-----------------|-----------------|-----------------|-----------------|
| <u>Loose Trim</u> (releasing device not incl.) | <u>10830</u> | <u>10830</u> | <u>10830</u> | <u>10830</u> | <u>10830</u> | <u>10830</u> | <u>10830</u> |
| | \$140.24 | \$140.24 | \$140.24 | \$140.24 | \$140.24 | \$140.24 | \$140.24 |
| <u>Modular Trim</u> (releasing device not incl.) | <u>10830P</u> | <u>10830P</u> | <u>10830P</u> | <u>10830P</u> | <u>10830P</u> | <u>10830P</u> | <u>10830P</u> |
| | \$605.38 | \$605.38 | \$605.38 | \$605.38 | \$605.38 | \$605.38 | \$605.38 |
| <u>Loose Trim - DOMESTIC</u> (releasing device not incl.) | <u>10830USA</u> | <u>10830USA</u> | <u>10830USA</u> | <u>10830USA</u> | <u>10830USA</u> | <u>10830USA</u> | <u>10830USA</u> |
| | \$186.96 | \$186.96 | \$186.96 | \$186.96 | \$186.96 | \$186.96 | \$186.96 |

| 1-1/2" | 2" | 2-1/2" | 3" | 4" | 6" | 8" |
|--------|----|--------|----|----|----|----|
|--------|----|--------|----|----|----|----|

Riser Check Valve and Trim (IPG V259 / V222)

| | | | | | | | |
|--|--------------|--------------|--------------|--------------|--------------|--------------|--------------|
| <u>Riser Check Valve</u> Threaded | <u>10659</u> | <u>10667</u> | N/A | N/A | N/A | N/A | N/A |
| | \$943.43 | \$1,090.78 | | | | | |
| <u>Riser Check Valve</u> Flange / Flange | N/A | N/A | N/A | <u>08505</u> | <u>08508</u> | <u>08511</u> | N/A |
| | | | | \$1,567.34 | \$1,614.94 | \$2,662.74 | |
| <u>Riser Check Valve</u> Flange / Groove | N/A | N/A | N/A | <u>08506</u> | <u>08509</u> | <u>08512</u> | <u>08515</u> |
| | | | | \$1,329.27 | \$1,368.22 | \$2,264.37 | \$3,205.01 |
| <u>Riser Check Valve</u> Groove / Groove | <u>11054</u> | <u>11059</u> | <u>07929</u> | <u>08507</u> | <u>08510</u> | <u>08513</u> | <u>08516</u> |
| | \$943.43 | \$1,090.78 | \$1,130.04 | \$1,130.04 | \$1,130.04 | \$2,091.24 | \$2,961.50 |
| <u>Riser Check Valve Trim</u> (For Preaction) | <u>12960</u> | <u>12960</u> | <u>13776</u> | <u>13776</u> | <u>13777</u> | <u>13777</u> | <u>13777</u> |
| | \$319.07 | \$319.07 | \$799.33 | \$799.33 | \$844.96 | \$844.96 | \$844.96 |

Riser check valve trim includes system main drain valve and air pressure gauge.

SureFire® Praction System - Single/Double Interlocked

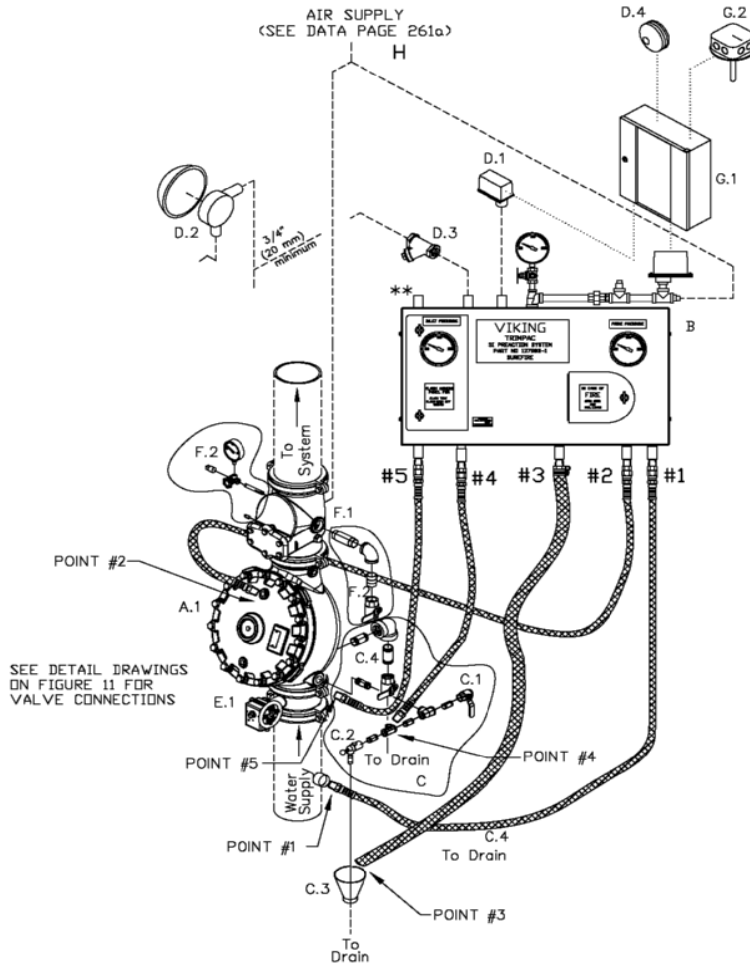

SUREFIRE SINGLE INTERLOCKED
PRACTION SYSTEM

- A System Valve
 - A.1 Deluge Valve
- B Trimpac
 - Trimpac Components (
- C Trimpac Drain Package
 - C.1 Auxiliary Drain Valve (NC)
 - C.2 Drip Check Valve
 - C.3 Drain Cup
 - C.4 Flow Test Valve (NC)
- D Water Flow Alarm Equipment
 - D.1 Alarm Pressure Switch
 - D.2 Water Motor Alarm (F-2) (Optional)
 - D.3 Strainer
 - D.4 Electric Alarm Bell
- E Riser
 - E.1 Water Supply Control Valve
- F Check Valve
 - F.1 2-1/2"-6" Easy Riser Check Valve
 - F.2 Check Valve Trim
- G Release System
 - G.1 Par-3 or VFR400 Release Control Pan (VFR400 Panel available 1st qtr. 2008)
 - G.2 Electric Detection System (Heat Detector shown for clarity)
- H Air Supply

SEE DETAIL DRAWINGS
ON FIGURE 11 FOR
VALVE CONNECTIONS

Components shown above are included in Quik Pik packages as customized by user. See page O-13.

Model F Deluge / Praction Valve* - STRAIGHT THROUGH

| V233 | 1-1/2" | 2" | 2-1/2" | 3" | 4" | 6" | 8" |
|-----------------|----------------------------|----------------------------|----------------------------|----------------------------|----------------------------|----------------------------|-----------------------------|
| Thread X Thread | <u>12126</u> \$4,027.62 | <u>12059</u> \$4,162.89 | <u>12401</u> \$5,497.16 | N/A | N/A | N/A | N/A |
| Flange X Flange | N/A | N/A | N/A | <u>12014</u> \$5,497.16 | <u>11953</u> \$7,160.55 | <u>11955</u> \$9,794.34 | <u>11991</u> \$22,185.37 |
| Flange X Groove | N/A | N/A | N/A | <u>12018</u> \$5,497.16 | <u>11952</u> \$7,160.55 | <u>11954</u> \$9,794.34 | N/A |
| Groove X Groove | <u>12125</u> \$4,027.62 | <u>12057</u> \$4,162.89 | <u>12403</u> \$5,497.16 | <u>12022</u> \$5,497.16 | <u>11513</u> \$7,160.55 | <u>11524</u> \$9,794.34 | <u>11018</u> \$22,185.37 |

See page O-19-20 for additional valve and trim options, including Halar® coated valves, horizontal trim, domestic trim, and brass trim packages.

* Valve is not included in trim packages. Please order separately. See following page for trim packages and equipment.

SureFire® Preaction System - Single/Double Interlocked

Viking's SureFire® fail safe preaction system is available in TrimPac arrangement only. Loose or modular trim not offered.

| TrimPac® ^{1,2,3} V234 | 1-1/2" | 2" | 2-1/2" | 3" | 4" | 6" | 8" |
|---|--------------------------------|--------------------------------|--------------------------------|--------------------------------|--------------------------------|--------------------------------|--------------------------------|
| Single Interlock <i>(includes release & trim)</i> | <u>13798D-1</u> \$9,656.66 | <u>13798D-1</u> \$9,656.66 | <u>13798D-1</u> \$9,656.66 | <u>13798D-1</u> \$9,656.66 | <u>13798D-1</u> \$9,656.66 | <u>13798D-1</u> \$9,656.66 | <u>13798D-1</u> \$9,656.66 |
| Double Interlock <i>(includes release & trim)</i> | <u>13799D-2</u> \$10,560.82 | <u>13799D-2</u> \$10,560.82 | <u>13799D-2</u> \$10,560.82 | <u>13799D-2</u> \$10,560.82 | <u>13799D-2</u> \$10,560.82 | <u>13799D-2</u> \$10,560.82 | <u>13799D-2</u> \$10,560.82 |

- (1) SureFire® TrimPac® systems include conventional trim, releasing device, releasing trim, and flexible hose kit.
- (2) Drain package for TrimPac® must be ordered separately (see below).
- (3) Galvanized trim. Brass trim options shown on page O-19.

Drain Package (IPG V257)

| Use with TrimPac® <i>(order separately)</i> | <u>11894-1</u> \$738.33 | <u>11894-2</u> \$597.20 | <u>11894-3</u> \$676.78 | <u>11894-3</u> \$676.78 | <u>11894-4</u> \$868.61 | <u>11894-4</u> \$868.61 | <u>11894-4</u> \$868.61 |
|--|----------------------------|----------------------------|----------------------------|----------------------------|----------------------------|----------------------------|----------------------------|
|--|----------------------------|----------------------------|----------------------------|----------------------------|----------------------------|----------------------------|----------------------------|

| | 1-1/2" | 2" | 2-1/2" | 3" | 4" | 6" | 8" |
|---|--------------------------|----------------------------|----------------------------|----------------------------|----------------------------|----------------------------|----------------------------|
| Riser Check Valve and Trim (IPG V259 / V222) | | | | | | | |
| Riser Check Valve Threaded | <u>10659</u> \$943.43 | <u>10667</u> \$1,090.78 | N/A | N/A | N/A | N/A | N/A |
| Riser Check Valve Flange / Flange | N/A | N/A | N/A | <u>08505</u> \$1,567.34 | <u>08508</u> \$1,614.94 | <u>08511</u> \$2,662.74 | N/A |
| Riser Check Valve Flange / Groove | N/A | N/A | N/A | <u>08506</u> \$1,329.27 | <u>08509</u> \$1,368.22 | <u>08512</u> \$2,264.37 | <u>08515</u> \$3,205.01 |
| Riser Check Valve Groove / Groove | <u>11054</u> \$943.43 | <u>11059</u> \$1,090.78 | <u>07929</u> \$1,130.04 | <u>08507</u> \$1,130.04 | <u>08510</u> \$1,130.04 | <u>08513</u> \$2,091.24 | <u>08516</u> \$2,961.50 |
| Riser Check Valve Trim (For Preaction) | <u>12960</u> \$319.07 | <u>12960</u> \$319.07 | <u>13776</u> \$799.33 | <u>13776</u> \$799.33 | <u>13777</u> \$844.96 | <u>13777</u> \$844.96 | <u>13777</u> \$844.96 |

Riser check valve trim includes system main drain valve and air pressure gauge.

Accessories for TrimPac®

| | | | | | | | | |
|--|------|--------------|-------------------|--|------|--------------|-----------------|-------------------|
| Replacement Hose PVC drain hose | V234 | <u>12071</u> | <u>\$196.74</u> | Riser Mounting Kit <i>(use when mounting TrimPac® unit to riser)</i> | V234 | Vertical | <u>11900</u> | <u>\$1,366.22</u> |
| | | | | | | Horizontal | <u>11901</u> | <u>\$1,878.64</u> |
| Air Line Trim - TANK MOUNTED <i>(not for use with Deluge TrimPac® Systems)</i> | V234 | <u>13770</u> | <u>\$2,470.23</u> | Air Line Trim - TANKLESS <i>(not for use with Deluge TrimPac® Systems)</i> | V234 | <u>13771</u> | <u>\$870.94</u> | |

Accessories and Additional Components

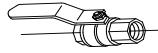

| <p>In-Line Check Valves</p> <p><u>Model K-1 (threaded)</u></p> <table border="1"> <tr> <td>1½"</td> <td>10659</td> <td>\$943.43</td> </tr> <tr> <td>2"</td> <td>10667</td> <td>\$1,090.78</td> </tr> </table> <p><u>Model L-1 (grooved)</u></p> <table border="1"> <tr> <td>1½"</td> <td>11054</td> <td>\$943.43</td> </tr> <tr> <td>2"</td> <td>11059</td> <td>\$1,090.78</td> </tr> </table> <p>IPG V259</p> | 1½" | 10659 | \$943.43 | 2" | 10667 | \$1,090.78 | 1½" | 11054 | \$943.43 | 2" | 11059 | \$1,090.78 | <p>In-Line Check Valve Trim (1-1/2" - 2")</p> <p><u>Model L-1 / K-1</u></p> <table border="1"> <tr> <td>12960</td> <td></td> </tr> <tr> <td>\$319.07</td> <td></td> </tr> </table> <p>IPG V222</p> | 12960 | | \$319.07 | | <p>Ball Valve  IPG V226</p> <table border="1"> <tr> <th colspan="3"><u>Brass</u></th> <th colspan="2"><u>Stainless Steel</u></th> </tr> <tr> <td>1/4"</td> <td>10354USA</td> <td>\$46.60</td> <td>10645</td> <td>\$374.63</td> </tr> <tr> <td>1/2"</td> <td>10355USA</td> <td>\$46.60</td> <td>10646</td> <td>\$597.54</td> </tr> <tr> <td>1"</td> <td>10356</td> <td>\$106.25</td> <td>10647</td> <td>\$724.32</td> </tr> <tr> <td></td> <td></td> <td></td> <td>10648</td> <td>\$1,380.66</td> </tr> <tr> <td></td> <td></td> <td></td> <td>10649</td> <td>\$1,874.07</td> </tr> </table> | <u>Brass</u> | | | <u>Stainless Steel</u> | | 1/4" | 10354USA | \$46.60 | 10645 | \$374.63 | 1/2" | 10355USA | \$46.60 | 10646 | \$597.54 | 1" | 10356 | \$106.25 | 10647 | \$724.32 | | | | 10648 | \$1,380.66 | | | | 10649 | \$1,874.07 |
|---|----------|------------|------------------------|------------|-------|------------|-----|-------|----------|----|-------|------------|---|-------|--|----------|--|---|--------------|--|--|------------------------|--|------|----------|---------|-------|----------|------|----------|---------|-------|----------|----|-------|----------|-------|----------|--|--|--|-------|------------|--|--|--|-------|------------|
| | 1½" | 10659 | \$943.43 | | | | | | | | | | | | | | | | | | | | | | | | | | | | | | | | | | | | | | | | | | | | | |
| 2" | 10667 | \$1,090.78 | | | | | | | | | | | | | | | | | | | | | | | | | | | | | | | | | | | | | | | | | | | | | | |
| 1½" | 11054 | \$943.43 | | | | | | | | | | | | | | | | | | | | | | | | | | | | | | | | | | | | | | | | | | | | | | |
| 2" | 11059 | \$1,090.78 | | | | | | | | | | | | | | | | | | | | | | | | | | | | | | | | | | | | | | | | | | | | | | |
| 12960 | | | | | | | | | | | | | | | | | | | | | | | | | | | | | | | | | | | | | | | | | | | | | | | | |
| \$319.07 | | | | | | | | | | | | | | | | | | | | | | | | | | | | | | | | | | | | | | | | | | | | | | | | |
| <u>Brass</u> | | | <u>Stainless Steel</u> | | | | | | | | | | | | | | | | | | | | | | | | | | | | | | | | | | | | | | | | | | | | | |
| 1/4" | 10354USA | \$46.60 | 10645 | \$374.63 | | | | | | | | | | | | | | | | | | | | | | | | | | | | | | | | | | | | | | | | | | | | |
| 1/2" | 10355USA | \$46.60 | 10646 | \$597.54 | | | | | | | | | | | | | | | | | | | | | | | | | | | | | | | | | | | | | | | | | | | | |
| 1" | 10356 | \$106.25 | 10647 | \$724.32 | | | | | | | | | | | | | | | | | | | | | | | | | | | | | | | | | | | | | | | | | | | | |
| | | | 10648 | \$1,380.66 | | | | | | | | | | | | | | | | | | | | | | | | | | | | | | | | | | | | | | | | | | | | |
| | | | 10649 | \$1,874.07 | | | | | | | | | | | | | | | | | | | | | | | | | | | | | | | | | | | | | | | | | | | | |

Pressure Operated Relief Valve (PORV) - Model D-3

 ½" / DN15
Brass
16970 \$2,024.12
IPG V242

Pressure Operated Relief Valve (PORV) - Model D-4

 ½" / DN15
Corrosion Resistant
16971 \$3,114.04
IPG V242

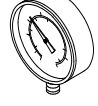
| <p>Restricted Orifice IPG V226</p> <p><u>1/4" (DN8)</u></p> <table border="1"> <tr> <td>1/16" (1.6mm)</td> <td>10110</td> <td>\$52.41</td> </tr> <tr> <td><u>Corrosion Resistant</u></td> <td></td> <td></td> </tr> <tr> <td>1/16" (1.6mm)</td> <td>10110J</td> <td>\$122.16</td> </tr> </table> | 1/16" (1.6mm) | 10110 | \$52.41 | <u>Corrosion Resistant</u> | | | 1/16" (1.6mm) | 10110J | \$122.16 | <p>Air Gauge</p> <p>0-300 psi (2068 kPa)</p> <p> <u>1/4" / DN8</u> VAIRSF \$29.92 IPG SR295</p> | <p>Globe Valve for Gauges (side outlet)</p> <p> <u>1/4" / DN8</u> 76V-25 \$26.52 IPG V226</p> | | | | | | | | | | | |
|---|--|--|----------------------------------|----------------------------|----------------------------|--|---|--|------------------|---|---|----------|---------|----------|--|--|--|-------|--|--|--|------------|
| 1/16" (1.6mm) | 10110 | \$52.41 | | | | | | | | | | | | | | | | | | | | |
| <u>Corrosion Resistant</u> | | | | | | | | | | | | | | | | | | | | | | |
| 1/16" (1.6mm) | 10110J | \$122.16 | | | | | | | | | | | | | | | | | | | | |
| <p>Drip Check Valve - Model D-1</p> <p>Velocity Check <u>3/4" / DN20</u></p> <table border="1"> <tr> <td>10730</td> <td>\$264.89</td> </tr> <tr> <td><u>Corrosion Resistant (D-4)</u></td> <td></td> </tr> <tr> <td>10733</td> <td>\$399.55</td> </tr> </table> <p>IPG V226</p> | 10730 | \$264.89 | <u>Corrosion Resistant (D-4)</u> | | 10733 | \$399.55 | <p>Drain Cup</p> <p> <u>1½" / DN40</u> 01019B \$25.94 IPG V226</p> | <p>Drain Check Valve IPG V226</p> <p><u>1/2" / DN15</u></p> <table border="1"> <tr> <td>05781A</td> <td>\$134.80</td> </tr> <tr> <td><u>Corrosion Resistant</u></td> <td></td> </tr> <tr> <td>05781AJ</td> <td>\$282.00</td> </tr> </table> | 05781A | \$134.80 | <u>Corrosion Resistant</u> | | 05781AJ | \$282.00 | | | | | | | | |
| 10730 | \$264.89 | | | | | | | | | | | | | | | | | | | | | |
| <u>Corrosion Resistant (D-4)</u> | | | | | | | | | | | | | | | | | | | | | | |
| 10733 | \$399.55 | | | | | | | | | | | | | | | | | | | | | |
| 05781A | \$134.80 | | | | | | | | | | | | | | | | | | | | | |
| <u>Corrosion Resistant</u> | | | | | | | | | | | | | | | | | | | | | | |
| 05781AJ | \$282.00 | | | | | | | | | | | | | | | | | | | | | |
| <p>Y Strainer IPG SR260</p> <p><u>1/4" / DN15</u></p> <p>14BYS \$41.13</p> | <p>Water Gauge</p> <p>0-300 psi</p> <p> <u>1/4" VWATERSF</u> \$29.92 IPG SR295</p> | <p>Prime Shut-Off Valve IPG V226</p> <p><u>1/2" / DN15</u></p> <table border="1"> <tr> <td>10723</td> <td>\$1,146.89</td> </tr> <tr> <td><u>Corrosion Resistant</u></td> <td></td> </tr> <tr> <td>10724</td> <td>\$2,049.98</td> </tr> </table> | 10723 | \$1,146.89 | <u>Corrosion Resistant</u> | | 10724 | \$2,049.98 | | | | | | | | | | | | | | |
| 10723 | \$1,146.89 | | | | | | | | | | | | | | | | | | | | | |
| <u>Corrosion Resistant</u> | | | | | | | | | | | | | | | | | | | | | | |
| 10724 | \$2,049.98 | | | | | | | | | | | | | | | | | | | | | |
| | <p>Restricted Orifice</p> <p><u>5/64" / 2mm</u></p> <table border="1"> <tr> <td><u>1/2" / DN15</u></td> <td></td> </tr> <tr> <td>11706</td> <td>\$108.25</td> </tr> </table> <p>IPG V226</p> | <u>1/2" / DN15</u> | | 11706 | \$108.25 | <p>In-Line Check Valve IPG V226</p> <p><u>1/4" / DN8</u></p> <table border="1"> <tr> <td>04947A</td> <td>\$125.39</td> </tr> </table> | 04947A | \$125.39 | | | | | | | | | | | | | | |
| <u>1/2" / DN15</u> | | | | | | | | | | | | | | | | | | | | | | |
| 11706 | \$108.25 | | | | | | | | | | | | | | | | | | | | | |
| 04947A | \$125.39 | | | | | | | | | | | | | | | | | | | | | |
| | <p>Emergency Release</p> <table border="1"> <tr> <th colspan="2"><u>1/2" (Galvanized)</u></th> <th><u>Brass</u></th> <th><u>Corrosion Resistant</u></th> </tr> <tr> <th colspan="2"><u>Model C-1</u></th> <th><u>Model C-2</u></th> <th><u>Model C-3</u></th> </tr> <tr> <td>01553C</td> <td>\$517.81</td> <td>09387</td> <td>\$863.74</td> </tr> <tr> <td></td> <td></td> <td></td> <td>09734</td> </tr> <tr> <td></td> <td></td> <td></td> <td>\$1,059.68</td> </tr> </table> <p>IPG V226</p> | | <u>1/2" (Galvanized)</u> | | <u>Brass</u> | <u>Corrosion Resistant</u> | <u>Model C-1</u> | | <u>Model C-2</u> | <u>Model C-3</u> | 01553C | \$517.81 | 09387 | \$863.74 | | | | 09734 | | | | \$1,059.68 |
| <u>1/2" (Galvanized)</u> | | <u>Brass</u> | <u>Corrosion Resistant</u> | | | | | | | | | | | | | | | | | | | |
| <u>Model C-1</u> | | <u>Model C-2</u> | <u>Model C-3</u> | | | | | | | | | | | | | | | | | | | |
| 01553C | \$517.81 | 09387 | \$863.74 | | | | | | | | | | | | | | | | | | | |
| | | | 09734 | | | | | | | | | | | | | | | | | | | |
| | | | \$1,059.68 | | | | | | | | | | | | | | | | | | | |

Accessories for TrimPac® (IPG V234)

| | | | | | | | | | | | | | | |
|---|---------------------|------------|------------|-----------------|-------|----------|--|--|-----------------|-------|------------|-------------------|-------|------------|
| <p>Air Line Trim</p> <p>(not for use with Deluge TrimPac System)</p> <table border="1"> <tr> <td><u>Tank Mounted</u></td> <td>13770</td> <td>\$2,470.23</td> </tr> <tr> <td><u>Tankless</u></td> <td>13771</td> <td>\$870.94</td> </tr> </table> | <u>Tank Mounted</u> | 13770 | \$2,470.23 | <u>Tankless</u> | 13771 | \$870.94 | <p>Replacement Hose</p> <p><u>PVC drain hose</u> 12071 \$196.74</p> | <p>Riser Mounting Kit</p> <p>(when mounting TrimPac to riser)</p> <table border="1"> <tr> <td><u>Vertical</u></td> <td>11900</td> <td>\$1,366.22</td> </tr> <tr> <td><u>Horizontal</u></td> <td>11901</td> <td>\$1,878.64</td> </tr> </table> | <u>Vertical</u> | 11900 | \$1,366.22 | <u>Horizontal</u> | 11901 | \$1,878.64 |
| <u>Tank Mounted</u> | 13770 | \$2,470.23 | | | | | | | | | | | | |
| <u>Tankless</u> | 13771 | \$870.94 | | | | | | | | | | | | |
| <u>Vertical</u> | 11900 | \$1,366.22 | | | | | | | | | | | | |
| <u>Horizontal</u> | 11901 | \$1,878.64 | | | | | | | | | | | | |



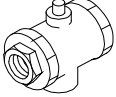
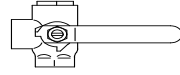
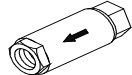

Accessories for Old Style Trim

| | | |
|--|--|--|
| <p>Model A-2 Strainer Orifice Check Vlv</p> <p> <u>1/4" (DN8)</u> 06579B \$492.32 V226</p> | <p>Alarm Test/Alarm Shut-Off Valve</p> <p> <u>1/2" (DN15)</u> 06174A \$530.09 V226</p> | <p>Spring Loaded Check Valve</p> <p>(with viton disc)</p> <p> <u>1/2" (DN15)</u> 12WILC \$272.56 SR140</p> |
|--|--|--|



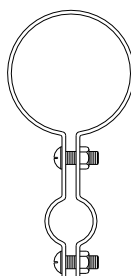

Accessories for Pneumatic Release Systems

| <p>Pneumatic Actuator</p>  <p>1/2" (DN15) Model H-1 06459B \$866.99 Corrosion Resistant (Model R-1) 09733 \$1,955.91</p> <p style="text-align: right;">IPG V226</p> | <p>Accelerator (Model E-1)</p>  <p>Model E-1 List 08055 \$2,143.90</p> <p style="text-align: right;">IPG V226</p> | | | | | | | | | | | | | | | | | | | | | |
|--|---|------------|------------|------------|----------|------------|---|------|--------|------------|-------------|-------|------------|-----------------|--|--|------|--------|------------|-------------|----------|------------|
| <p>Model D-2 - Air Pressure Maintenance Device</p>  <table border="1"> <thead> <tr> <th>Size</th> <th>Part #</th> <th>List Price</th> </tr> </thead> <tbody> <tr> <td>1/4" / DN8</td> <td>02280C</td> <td>\$1,023.63</td> </tr> </tbody> </table> <p style="text-align: right;">IPG V226</p> | Size | Part # | List Price | 1/4" / DN8 | 02280C | \$1,023.63 | <p>Model D-2 - Air Pressure Maintenance Device</p>  <table border="1"> <thead> <tr> <th>Size</th> <th>Part #</th> <th>List Price</th> </tr> </thead> <tbody> <tr> <td>1/2" / DN15</td> <td>07459</td> <td>\$1,798.81</td> </tr> <tr> <td colspan="3" style="text-align: center;">DOMESTIC</td> </tr> <tr> <th>Size</th> <th>Part #</th> <th>List Price</th> </tr> <tr> <td>1/2" / DN15</td> <td>07459USA</td> <td>\$2,398.40</td> </tr> </tbody> </table> <p style="text-align: right;">IPG V226</p> | Size | Part # | List Price | 1/2" / DN15 | 07459 | \$1,798.81 | DOMESTIC | | | Size | Part # | List Price | 1/2" / DN15 | 07459USA | \$2,398.40 |
| Size | Part # | List Price | | | | | | | | | | | | | | | | | | | | |
| 1/4" / DN8 | 02280C | \$1,023.63 | | | | | | | | | | | | | | | | | | | | |
| Size | Part # | List Price | | | | | | | | | | | | | | | | | | | | |
| 1/2" / DN15 | 07459 | \$1,798.81 | | | | | | | | | | | | | | | | | | | | |
| DOMESTIC | | | | | | | | | | | | | | | | | | | | | | |
| Size | Part # | List Price | | | | | | | | | | | | | | | | | | | | |
| 1/2" / DN15 | 07459USA | \$2,398.40 | | | | | | | | | | | | | | | | | | | | |
| <p>Dehydrator Package</p> <p>Includes:</p> <ul style="list-style-type: none"> - Desiccant 1/4" (DN8) 16854 \$2,421.97 - Mounting Brackets - Nipples Extra Desiccant* 16855 \$548.37 <p>*one unit fills dehydrator</p> <p style="text-align: right;">IPG V226</p> | <p>Replacement Restriction</p> <p>Release Line Air Supply</p>  <table border="1"> <thead> <tr> <th>Part #</th> <th>List Price</th> </tr> </thead> <tbody> <tr> <td>02902B</td> <td>\$248.01</td> </tr> </tbody> </table> <p style="text-align: right;">IPG V226</p> | Part # | List Price | 02902B | \$248.01 | | | | | | | | | | | | | | | | | |
| Part # | List Price | | | | | | | | | | | | | | | | | | | | | |
| 02902B | \$248.01 | | | | | | | | | | | | | | | | | | | | | |

Accessories for Pneumatic and Hydraulic Systems

| | | | | | | | | | | | | | | | | | | | | | | | | | | | | | | | | | | |
|---|---|-----------|---------|---------|---------------|---------|---------|---------------|---------|---|-----------|---------|---------|---------------|---------|---------|-----------|-------|---------|---------------|-------|---------|------------|-------|---------|------------|-------|---------|------------|-------|---------|------------|-------|---------|
| <p>Thermostatic Release (Model C-1)</p> <p>(Includes 155°F/68°C fixed temperature release)</p> <p>- indoor and outdoor use Standard 01432C \$2,293.21</p> <p>Nitrogen Tested 05006A \$2,470.35</p>  <p style="text-align: right;">IPG V226</p> | <p>Thermostatic Release (Model C-2)</p> <p>(Includes 155°F/68°C fixed temperature release)</p> <p>- indoor and outdoor use Standard 03991C-18 \$2,728.86</p> <p>- corrosion resistant Nitrogen Tested 10367 \$2,906.02</p> <p>- for use in salt water environments</p> <p style="text-align: right;">IPG V226</p> | | | | | | | | | | | | | | | | | | | | | | | | | | | | | | | | | |
| <p>Fixed Temperature Release (Model M HP - VK800)</p> <p>1/2" (15 mm) - RATED TO 250 PSI (1724 kPa) IPG V226</p>  <table border="1"> <tbody> <tr> <td>Brass</td> <td>07848AB</td> <td>\$72.74</td> </tr> <tr> <td>Chrome</td> <td>07848FB</td> <td>\$77.98</td> </tr> <tr> <td>White</td> <td>07848MB/W</td> <td>\$79.48</td> </tr> </tbody> </table> <p>Add the temperature suffix to the part number (155 deg shown): (°F/°C) A=135°/57°, B=155°/68°, D=175°/79°, E=200°/93°, G=286°/141°</p> | Brass | 07848AB | \$72.74 | Chrome | 07848FB | \$77.98 | White | 07848MB/W | \$79.48 | <p>Replacement Fixed Temperature Release</p> <p>155°F/68°C</p>  <table border="1"> <tbody> <tr> <td>Model C-1</td> <td>07848FB</td> <td>\$77.98</td> </tr> <tr> <td>Model C-2</td> <td>07848CB</td> <td>\$92.98</td> </tr> </tbody> </table> <p style="text-align: right;">IPG V226</p> | Model C-1 | 07848FB | \$77.98 | Model C-2 | 07848CB | \$92.98 | | | | | | | | | | | | | | | | | | |
| Brass | 07848AB | \$72.74 | | | | | | | | | | | | | | | | | | | | | | | | | | | | | | | | |
| Chrome | 07848FB | \$77.98 | | | | | | | | | | | | | | | | | | | | | | | | | | | | | | | | |
| White | 07848MB/W | \$79.48 | | | | | | | | | | | | | | | | | | | | | | | | | | | | | | | | |
| Model C-1 | 07848FB | \$77.98 | | | | | | | | | | | | | | | | | | | | | | | | | | | | | | | | |
| Model C-2 | 07848CB | \$92.98 | | | | | | | | | | | | | | | | | | | | | | | | | | | | | | | | |
| <p>Operation Indicator</p> <p>Includes: 1/2" (DN15) 02944A \$89.97</p> <p>- indoor and outdoor use</p> <p>- corrosion resistant</p> <p style="text-align: right;">IPG V226</p> | <p>Adjustment Kit</p> <p>Includes:</p> <ul style="list-style-type: none"> - indoor and outdoor use - corrosion resistant  <p>Model C-1 and C-2 01714A \$274.18</p> <p style="text-align: right;">IPG V226</p> | | | | | | | | | | | | | | | | | | | | | | | | | | | | | | | | | |
| <p>Release Line Hangers IPG V226</p>  <p>(includes two screws/nuts)</p> <table border="1"> <tbody> <tr> <td>1" / DN25</td> <td>09574</td> <td>\$30.64</td> </tr> <tr> <td>1 1/4" / DN32</td> <td>09575</td> <td>\$30.64</td> </tr> <tr> <td>1 1/2" / DN40</td> <td>09576</td> <td>\$30.64</td> </tr> <tr> <td>2" / DN50</td> <td>09577</td> <td>\$30.64</td> </tr> <tr> <td>2 1/2" / DN65</td> <td>09578</td> <td>\$30.64</td> </tr> <tr> <td>3" / DN80</td> <td>09579</td> <td>\$30.64</td> </tr> </tbody> </table> <table border="1"> <tbody> <tr> <td>3 1/2" / DN90</td> <td>09580</td> <td>\$30.64</td> </tr> <tr> <td>4" / DN100</td> <td>09581</td> <td>\$44.80</td> </tr> <tr> <td>5" / DN125</td> <td>09582</td> <td>\$44.80</td> </tr> <tr> <td>6" / DN150</td> <td>09583</td> <td>\$44.80</td> </tr> <tr> <td>8" / DN200</td> <td>09584</td> <td>\$44.80</td> </tr> </tbody> </table> <p style="text-align: center;">Stainless steel available upon request at additional cost. Add suffix "SST" to base part number.</p> | | 1" / DN25 | 09574 | \$30.64 | 1 1/4" / DN32 | 09575 | \$30.64 | 1 1/2" / DN40 | 09576 | \$30.64 | 2" / DN50 | 09577 | \$30.64 | 2 1/2" / DN65 | 09578 | \$30.64 | 3" / DN80 | 09579 | \$30.64 | 3 1/2" / DN90 | 09580 | \$30.64 | 4" / DN100 | 09581 | \$44.80 | 5" / DN125 | 09582 | \$44.80 | 6" / DN150 | 09583 | \$44.80 | 8" / DN200 | 09584 | \$44.80 |
| 1" / DN25 | 09574 | \$30.64 | | | | | | | | | | | | | | | | | | | | | | | | | | | | | | | | |
| 1 1/4" / DN32 | 09575 | \$30.64 | | | | | | | | | | | | | | | | | | | | | | | | | | | | | | | | |
| 1 1/2" / DN40 | 09576 | \$30.64 | | | | | | | | | | | | | | | | | | | | | | | | | | | | | | | | |
| 2" / DN50 | 09577 | \$30.64 | | | | | | | | | | | | | | | | | | | | | | | | | | | | | | | | |
| 2 1/2" / DN65 | 09578 | \$30.64 | | | | | | | | | | | | | | | | | | | | | | | | | | | | | | | | |
| 3" / DN80 | 09579 | \$30.64 | | | | | | | | | | | | | | | | | | | | | | | | | | | | | | | | |
| 3 1/2" / DN90 | 09580 | \$30.64 | | | | | | | | | | | | | | | | | | | | | | | | | | | | | | | | |
| 4" / DN100 | 09581 | \$44.80 | | | | | | | | | | | | | | | | | | | | | | | | | | | | | | | | |
| 5" / DN125 | 09582 | \$44.80 | | | | | | | | | | | | | | | | | | | | | | | | | | | | | | | | |
| 6" / DN150 | 09583 | \$44.80 | | | | | | | | | | | | | | | | | | | | | | | | | | | | | | | | |
| 8" / DN200 | 09584 | \$44.80 | | | | | | | | | | | | | | | | | | | | | | | | | | | | | | | | |

Accessories for Electric Release Systems

| SOLENOID VALVES (1/2" / DN15) | | | IPG V240 | |
|---|--|---------------|-----------------|-------------------|
| Normally Closed (rated to 250 psi (1724 kPa)) | | | | |
|  | <u>Deluge & Preaction, SureFire</u> | | Part No. | List Price |
| | NEMA 1,2,3,3S,4,4X | 24 VDC | 11601 | \$1,345.64 |
|  | <u>Explosion Proof</u> | | | |
| | NEMA 3,3S,4,4X,6,6P,7,9 | 24 VDC | 11602 | \$2,248.90 |
| Normally Closed (rated to 300 psi (2068 kPa)) | | | | |
|  | <u>Firecycle III, TotalPac & Special Application</u> | | | |
| | NEMA 2,3,3S,4,4X | 24 VDC | 11591 | \$1,718.09 |
| | NEMA 1,2,3,3S,4,4X | 110 VAC/50 HZ | 11593 | \$1,461.98 |
| | NEMA 1,2,3,3S,4,4X | 120 VAC/60 HZ | 11594 | \$1,988.14 |
| | <u>Explosion Proof</u> | | | |
| | NEMA 3,3S,4,4X,6,6P,7,9 | 24 VDC | 11592 | \$2,248.90 |
| | NEMA 3,3S,4,4X,6,6P,7,9 | 110 VAC/50 HZ | 11594 | \$1,988.14 |
| | NEMA 3,3S,4,4X,6,6P,7,9 | 120 VAC/60 HZ | 11594 | \$1,988.14 |
| ATEX, EEx, mII, T4/T5 | 110 VAC/50 HZ | 12359 | \$2,360.56 | |
| ATEX, EEx, mII, T4/T5 | 24 VDC | 12360 | \$2,621.35 | |
| Normally Open (rated to 300 psi (2068 kPa)) | | | | |
|  | <u>Firecycle III</u> | | | |
| | NEMA 2,3,3S,4,4X | 24 VDC | 11595 | \$2,858.84 |
| | <u>Surefire & TrimPac</u> | | | |
| | NEMA 2,3,3S,4,4X | 24 VDC | 13215 | \$2,858.84 |
| | <u>Explosion Proof</u> | | | |
| NEMA 3,3S,4,4X,6,6P,7,9 | 24 VDC | 11596 | \$3,985.58 | |
| ATEX, EEx, mII, T4/T5 | 24 VDC | 12358 | \$4,357.96 | |

| RELEASE CONTROL PANEL (VFR-500) | | | IPG V241 | |
|---|-----------------|-------------------|---|-------------------|
| VFR-500 Release Control Panel | | | | |
| <ul style="list-style-type: none"> - Contains seven user-definable zones and menu-driven programming controls - Up to 35 standard programs in memory and programmable cross-zoning - Multi-directional navigation through the panel history and menus - cULus Listed and FM Approved for agent and/or water-based extinguishing | Part No. | List Price |  <p>* see below for accessories and optional modules</p> | |
| | 26107 | \$5,790.17 | | |
| Optional Modules / Accessories | Part No. | List Price | Batteries (two required per panel) | |
| CA2Z Module (class A initiating device circuit): | 14155 | \$334.42 | | |
| CAM2 Module (class A indicating appliance circuit): | 14156 | \$384.58 | Part No. | List Price |
| ARM-1/ARM-2 Module (auxiliary relay module): | 14157 | \$484.91 | 8 Amp | 07920 P.O.A. |
| RA-4410-RC (remote annunciator): | 14154 | \$1,755.69 | 12 Amp | 07921 P.O.A. |
| | | | 18 Amp | 09867 P.O.A. |
| MR-101/T SPDT Relay Module: | 14159 | \$196.50 | Battery Cabinet (for 18 amp hr battery) | |
| MR-201 DPDT Relay Module: | 14160 | \$246.62 | Part No. | List Price |
| MR801/T SPDT Relay w/Led Indicator: | 14161 | \$104.51 | 09866 | \$978.85 |
| ELOD Resistor/Diode: | 14162 | \$50.16 | | |
| ELOR Resistor: | 14163 | \$4.20 | | |

Alarm Devices

Alarm Pressure Switch - SR020

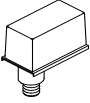
| | | | | | |
|---|--------|----------|--------------------------------|---------|------------|
| <u>Adjustable Range (4-20 psi)</u> | | | <u>Explosion Proof</u> | | |
| <u>1/2" / DN50</u> | | | Dual SPDT | PS10-EX | \$1,894.79 |
| Single SPDT | PS101A | \$269.05 | Dual SPDT | PS40EX | \$1,894.79 |
| Dual SPDT | PS102A | \$324.36 | * Cenelec approved | | |
| * Manufactured by Potter | | | <u>Pressure Adj Access Key</u> | | |
|  | | | 10600 \$38.42 | | |
| | | | <u>Cover Removal Key</u> | | |
| | | | 10601 \$38.42 | | |

* Appropriate hex keys included with switches.

Pressure Supervisory Switch (Air, Nitrogen, Water) - IPG SR020

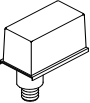

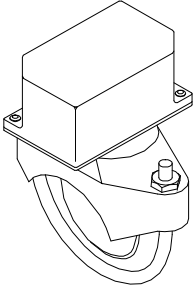

| | | | | | |
|---|--------|----------|--------------------------------|-------|------------|
| <u>Adjustable Range (10-175 psi)</u> | | | <u>Explosion Proof</u> | | |
| <u>1/2" / DN50</u> | | | Dual SPDT | 10379 | \$2,531.67 |
| Single SPDT | PS401A | \$269.05 | * Cenelec approved | | |
| Dual SPDT | PS402A | \$324.36 | <u>Pressure Adj Access Key</u> | | |
| * Manufactured by Potter | | | 10600 \$38.42 | | |
|  | | | <u>Cover Tamper Switch Kit</u> | | |
| | | | 09601 \$196.51 | | |
| | | | <u>Cover Removal Key</u> | | |
| | | | 10601 \$38.42 | | |

* Appropriate hex keys included with switches.

Flow Switch - SR010

| | | | | |
|--|----------|----------|--|--|
| <u>Waterflow Indicators</u> | | | |  |
| (adjustable retard up to 120 sec. - 2 SPDT contacts) | | | | |
| <u>Model VSR</u> | | | | |
| 1-2" / DN40 | VSRF0100 | \$390.46 | | |
| 2" / DN50 | VSRF0200 | \$422.48 | | |
| 2½" / DN65 | VSRF0250 | \$422.48 | | |
| 3" / DN80 | VSRF0300 | \$422.48 | | |
| 3½" / DN90 | VSRF0350 | \$422.48 | | |
| 4" / DN100 | VSRF0400 | \$422.48 | | |
| 5" / DN125 | VSRF0500 | \$422.48 | | |
| 6" / DN150 | VSRF0600 | \$422.48 | | |
| 8" / DN200 | VSRF0800 | \$473.72 | | |

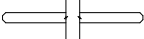
Water Motor Alarm and Accessories - IPG V226

| | | | | | |
|---|--|--|---|--|--|
| <u>Water Motor Alarm</u> | | | <u>Closure Plate</u> | | |
|  | | |  | | |
| <u>Model F-2</u> 07862 \$873.25 | | | 05820B \$178.23 | | |
| <u>Adjustable Shaft</u> | | | <u>Alarm Line Y Strainer</u> | | |
| (wall thickness up to 30-1/4 in / 768 mm) | | |  | | |
|  | | | <u>3/4" (DN20)</u> 01489A \$260.03 | | |
| <u>Extension Cup</u> | | | | | |
|  | | | 05957B \$142.59 | | |

Special Valves and Trim

Halar® Coated Deluge / Preaction Valves (Model F-2)

Straight-Through (Model F-2)

| IPG V233 | 1-1/2" | 2" | 2-1/2" | 3" | 4" | 6" | 8" |
|--------------------|-------------------------------|-------------------------------|-------------------------------|-------------------------------|--------------------------------|--------------------------------|--------------------------------|
| Thread X Thread | N/A | N/A | <u>12402Q/B</u> \$8,612.28 | N/A | N/A | N/A | N/A |
| Flange X Flange | N/A | N/A | N/A | <u>12015Q/B</u> \$8,612.28 | <u>11960Q/B</u> \$11,522.52 | <u>11962Q/B</u> \$15,418.86 | <u>11992Q/B</u> \$32,278.39 |
| Flange X Groove | N/A | N/A | N/A | <u>12019Q/B</u> \$8,612.28 | <u>11959Q/B</u> \$11,522.52 | <u>11961Q/B</u> \$15,418.86 | N/A |
| Groove X Groove | <u>12127Q/B</u> \$6,380.79 | <u>12058Q/B</u> \$6,398.15 | <u>12404Q/B</u> \$8,612.28 | <u>12023Q/B</u> \$8,612.28 | <u>11514Q/B</u> \$11,522.52 | <u>11525Q/B</u> \$15,418.86 | <u>11118Q/B</u> \$30,719.06 |

HORIZONTAL TRIM - Conventional Deluge / Preaction Trim

Galvanized (use with straight through valves)

| IPG V236 | 1-1/2" | 2" | 2-1/2" | 3" | 4" | 6" | 8" |
|---|-------------------------------|-------------------------------|-------------------------------|-------------------------------|-------------------------------|-------------------------------|-------------------------------|
| Loose Trim <i>(incl. accessory pkg-09316)</i> | <u>14635-1</u> \$4,488.91 | <u>14635-1</u> \$4,488.91 | <u>14637-1</u> \$4,392.98 | <u>14637-1</u> \$4,392.98 | <u>14638-1</u> \$4,596.80 | <u>14640-1</u> \$4,607.59 | <u>14643-1</u> \$6,674.29 |
| Modular Trim <i>(incl. accessory pkg-09316)</i> | <u>14635-1P</u> \$4,894.21 | <u>14635-1P</u> \$4,894.21 | <u>14637-1P</u> \$4,798.23 | <u>14637-1P</u> \$4,798.23 | <u>14638-1P</u> \$5,003.98 | <u>14640-1P</u> \$5,014.73 | <u>14643-1P</u> \$7,081.44 |

BRASS TRIMS - Conventional Deluge / Preaction Trim

Straight Through Valves - VERTICAL

| IPG V237 | 1-1/2" | 2" | 2-1/2" | 3" | 4" | 6" | 8" |
|---|-------------------------------|-------------------------------|-------------------------------|-------------------------------|-------------------------------|-------------------------------|------------------------------|
| Loose Trim <i>(incl. accessory pkg-09316)</i> | <u>14634-2</u> \$7,619.45 | <u>14634-2</u> \$7,619.45 | <u>14636-2</u> \$7,236.54 | <u>14636-2</u> \$7,236.54 | <u>14639-2</u> \$7,732.33 | <u>14641-2</u> \$7,821.58 | <u>14642-2</u> \$9,745.79 |
| Modular Trim <i>(incl. accessory pkg-09316)</i> | <u>14634-2P</u> \$8,046.95 | <u>14634-2P</u> \$8,046.95 | <u>14636-2P</u> \$7,664.04 | <u>14636-2P</u> \$7,664.04 | <u>14639-2P</u> \$8,159.83 | <u>14641-2P</u> \$8,249.06 | <u>14642-2P</u> P.O.A. |

Straight Through Valves - HORIZONTAL

| IPG V237 | 1-1/2" | 2" | 2-1/2" | 3" | 4" | 6" | 8" |
|---|-------------------------------|-------------------------------|------------------------------|------------------------------|------------------------------|-------------------------------|------------------------------|
| Loose Trim <i>(incl. accessory pkg-09316)</i> | <u>14635-2</u> \$7,619.45 | <u>14635-2</u> \$7,619.45 | <u>14637-2</u> \$7,236.54 | <u>14637-2</u> \$7,236.54 | <u>14638-2</u> \$7,732.33 | <u>14640-2</u> \$7,821.58 | <u>14643-2</u> \$9,745.79 |
| Modular Trim <i>(incl. accessory pkg-09316)</i> | <u>14635-2P</u> \$8,046.95 | <u>14635-2P</u> \$8,046.95 | <u>14637-2P</u> P.O.A. | <u>14637-2P</u> P.O.A. | <u>14638-2P</u> P.O.A. | <u>14640-2P</u> \$8,249.06 | <u>14643-2P</u> P.O.A. |

Special Valves and Trim

DOMESTIC TRIM ¹ - Model F - Galvanized

Straight Through Valves - VERTICAL

| V236 | 1-1/2" | 2" | 2-1/2" | 3" | 4" | 6" | 8" |
|-------------------|-------------------|-------------------|-------------------|-------------------|-------------------|-------------------|-------------------|
| <u>Loose Trim</u> | <u>14634-1USA</u> | <u>14634-1USA</u> | <u>14636-1USA</u> | <u>14636-1USA</u> | <u>14639-1USA</u> | <u>14641-1USA</u> | <u>14642-1USA</u> |
| | \$5,985.21 | \$5,985.21 | \$5,857.31 | \$5,857.31 | \$6,129.11 | \$6,143.44 | \$8,899.05 |

DOMESTIC TRIM - Easy Riser® System

| Size | Trim (loose) | |
|----------------------|--------------|------------|
| IPG | V222 | |
| Model K-1/L-1 | | |
| 1-1/2" | 12960USA | \$455.83 |
| 2" | 12960USA | \$455.83 |
| Model E-1/F-1 | | |
| 2-1/2" | 13776USA | \$1,141.94 |
| 3" | 13776USA | \$1,141.94 |
| 4" | 13777USA | \$878.95 |
| 6" | 13777USA | \$878.95 |
| 8" | 13777USA | \$878.95 |

BRASS TRIM - Easy Riser® System

| Size | Trim (loose) | | Trim (modular) | |
|---|--------------|------------|----------------|--------|
| IPG | V222 | | V222 | |
| Model K-1/L-1 - In-Line Check Valve Trim | | | | |
| 1-1/2" | 12960-1 | \$539.49 | 12960-1P | P.O.A. |
| 2" | 12960-1 | \$539.49 | 12960-1P | P.O.A. |
| Model E-1/F-1 - Easy Riser Valve Trim | | | | |
| 2-1/2" | 07236-1 | \$1,351.35 | 07236-1P | P.O.A. |
| 3" | 07236-1 | \$1,351.35 | 07236-1P | P.O.A. |
| 4" | 07237-1 | \$1,428.48 | 07237-1P | P.O.A. |
| 6" | 07237-1 | \$1,428.48 | 07237-1P | P.O.A. |
| 8" | 07237-1 | \$1,428.48 | 07237-1P | P.O.A. |

BRASS - SureFire® TrimPac®

| Single Interlocked | |
|--------------------|-------------|
| V234 | |
| 13798D-1B | \$13,191.48 |

| Double Interlocked | |
|--------------------|-------------|
| V234 | |
| 13799D-2B | \$13,551.85 |

BRASS - Releasing Trims

| | Pneumatic | Electric Pneumatic | Electric | Pneumatic Pneumatic | <u>DOMESTIC ¹</u> Electric |
|--|--------------------------|----------------------------|--------------------------|------------------------------|--|
| IPG | V239 | V239 | V239 | V239 | V239 |
| <u>Loose Trim</u> <i>(releasing device not incl.)</i> | <u>10811</u> \$370.11 | <u>12661-2</u> \$308.95 | <u>10832</u> \$416.45 | <u>12662-2</u> \$1,971.20 | <u>10832USA</u> \$555.26 |
| <u>Modular Trim</u> <i>(releasing device not incl.)</i> | <u>10811-P</u> P.O.A. | <u>12661-2P</u> P.O.A. | <u>10832-P</u> P.O.A. | <u>12662-2P</u> P.O.A. | <u>10832USA-P</u> P.O.A. |

(1) Meets sourcing requirements of the Buy American Act, American Reinvestment and Recovery Act, and the Buy American Law. Contact customer service for availability.