



Section N
Deluge Systems

TABLE OF CONTENTS

Deluge System – Pneumatic Release	N-1 – N-2
Deluge System – Hydraulic Release.....	N-3 – N-4
Deluge System – Electric Release.....	N-5 – N-6
Components and Accessories (general)	N-7
Accessories (Pneumatic Release)	N-8
Accessories (Hydraulic Release)	N-8
Accessories (Electric Release)	N-9
Alarm Devices.....	N-10
Special Valves and Trim (Halar® coated valves, brass trim, stainless steel, etc.)	N-11 – N-12
Deluge Valve Model VXD	N-13

Notes

1. Refer to Viking technical data pages for complete product specifications. You may print or download technical data by visiting www.vikinggroupinc.com.
2. List prices effective July 9, 2022. Supersedes February 2022 list price book.
3. All sales by Viking are subject to the terms & conditions found on the last page of this book.

Deluge System - Pneumatic Release

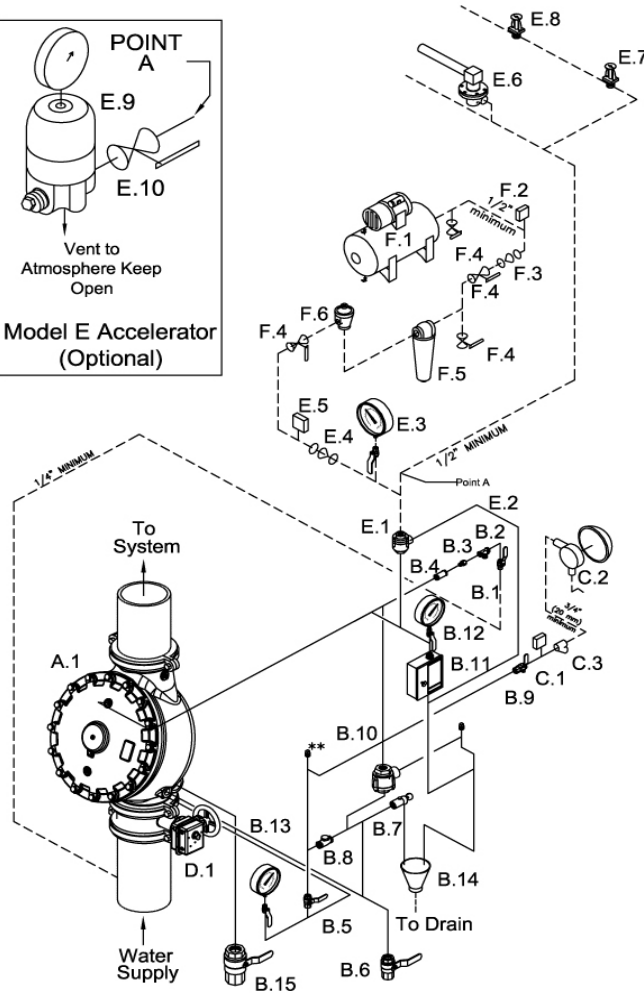
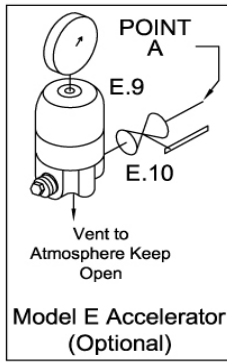

SYSTEM COMPONENTS

- A. Valve
 - A.1 Deluge Valve
- B. Deluge Valve Conventional Trim *
 - (See Deluge Valve Conventional Trim Charts)
 - B.1 Priming Valve (Normally Open)
 - B.2 Strainer
 - B.3 1/16" Restriction
 - B.4 Spring Loaded Check Valve
 - B.5 Alarm Test Valve (Normally Closed)
 - B.6 Auxiliary Drain Valve (Normally Closed)
 - B.7 Drip Check Valve
 - B.8 Drain Check Valve
 - B.9 Alarm Shut-Off Valve (Normally Open)
 - B.10 Pressure Operated Relief Valve (P.O.R.V.)
 - B.11 Emergency Release
 - B.12 Priming Pressure Water Gauge and Valve
 - B.13 Water Supply Pressure Gauge and Valve
 - B.14 Drain cup
 - B.15 Flow Test Valve (Normally Closed)
- C. Water Flow Alarm Equipment
 - C.1 Alarm Pressure Switch and/or
 - C.2 Water Motor Alarm (Strainer Required)
 - C.3 Strainer
- D. Riser
 - D.1 Water Supply Control Valve
- E. Release System
 - E.1 Pneumatic Actuator
 - E.2 Pneumatic Release Module
(See Pneumatic Release Module Trim Chart)
 - E.3 Air Pressure Gauge and Valve
 - E.4 Soft Seat Check Valve
 - E.5 Air Pressure Supervisory Switch
 - E.6 Thermostatic Release and/or
 - E.7 Fixed Temperature Release and/or
 - E.8 Pilot Head (Sprinkler)
 - E.9 Accelerator (Optional. See Inset.)
 - E.10 Accelerator Isolation Valve. (See Inset.)
- F. Air Supply
 - F.1 Automatic Air Supply. Air Compressor and Tank shown for clarity.
 - F.2 Air Supervisory Pressure Switch (Compressor On/Off Control Switch)
 - F.3 Soft Seat Check Valve
 - F.4 Shut Off Valve (Indicating Ball Valve recommended.)
 - F.5 Dehydrator
 - F.6 Air maintenance Device & By-Pass Trim

----- Dashed lines indicate pipe required but not included with Deluge Valve Conventional Trim Packages.

- * Viking Deluge Valve Trim Packages contain items B.1 through B.15 and associated nipples. Viking Accessory Package for Conventional Deluge Valve Trim contains B.2 through B.5, B.7 through B.11, and B.14.
- * * 1/2" (15 mm) NPT for Non-Interruptible Alarm Pressure Switch (Optional)

Above components are included in QuikPik packages as customized by user. See page N-2

Model F Deluge / Preaction Valve* - STRAIGHT THROUGH

V233	1-1/2"	2"	2-1/2"	3"	4"	6"	8"
Thread X Thread	<u>12126</u> \$4,027.62	<u>12059</u> \$4,162.89	<u>12401</u> \$5,497.16	N/A	N/A	N/A	N/A
Flange X Flange	N/A	N/A	N/A	<u>12014</u> \$5,497.16	<u>11953</u> \$7,160.55	<u>11955</u> \$9,794.34	<u>11991</u> \$22,185.37
Flange X Groove	N/A	N/A	N/A	<u>12018</u> \$5,497.16	<u>11952</u> \$7,160.55	<u>11954</u> \$9,794.34	N/A
Groove X Groove	<u>12125</u> \$4,027.62	<u>12057</u> \$4,162.89	<u>12403</u> \$5,497.16	<u>12022</u> \$5,497.16	<u>11513</u> \$7,160.55	<u>11524</u> \$9,794.34	<u>11018</u> \$22,185.37

See page N-11/12 for additional valve and trim options, including Halar® coated valves, horizontal trim, and brass trim packages.

* Valve is not included in trim packages. Please order separately. See following page for trim packages and equipment.

Deluge System - Pneumatic Release

TrimPac®	V234	1-1/2"	2"	2-1/2"	3"	4"	6"	8"
<u>Straight-Through</u>		<u>13788B-2</u>	<u>13788B-2</u>	<u>13788B-2</u>	<u>13788B-2</u>	<u>13788B-2</u>	<u>13788B-2</u>	<u>13788B-2</u>
		\$7,023.02	\$7,023.02	\$7,023.02	\$7,023.02	\$7,023.02	\$7,023.02	\$7,023.02

TrimPac® includes conventional trim, releasing device (pneumatic actuator), releasing trim, and flexible hose kit.

Drain package for TrimPac® must be ordered separately (see below).

Drain Package (IPG V257)

<u>Use with TrimPac®</u>	<u>11894-1</u>	<u>11894-2</u>	<u>11894-3</u>	<u>11894-3</u>	<u>11894-4</u>	<u>11894-4</u>	<u>11894-4</u>
(order separately)	\$738.33	\$597.20	\$676.78	\$676.78	\$868.61	\$868.61	\$868.61

	1-1/2"	2"	2-1/2"	3"	4"	6"	8"
--	--------	----	--------	----	----	----	----

Trim (Vertical - Straight Through Valve) - Galvanized (IPG V236)

<u>Loose Trim</u>	<u>14634-1</u>	<u>14634-1</u>	<u>14636-1</u>	<u>14636-1</u>	<u>14639-1</u>	<u>14641-1</u>	<u>14642-1</u>
(incl. accessory pkg-09316)	\$4,488.91	\$4,488.91	\$4,392.98	\$4,392.98	\$4,596.80	\$4,607.59	\$6,674.29
<u>Modular Trim</u>	<u>14634-1P</u>	<u>14634-1P</u>	<u>14636-1P</u>	<u>14636-1P</u>	<u>14639-1P</u>	<u>14641-1P</u>	<u>14642-1P</u>
(incl. accessory pkg-09316)	\$4,894.21	\$4,894.21	\$4,798.23	\$4,798.23	\$5,003.98	\$5,014.73	\$7,081.44

Trim (Vertical - Angle Style Valve) - Galvanized (IPG V236)

<u>Loose Trim</u>	<u>14629-1</u>	<u>14630-1</u>	N/A	<u>14631-1</u>	<u>14632-1</u>	<u>14633-1</u>	N/A
(incl. accessory pkg-09316)	\$4,700.66	\$4,524.53		\$4,600.19	\$4,813.68	\$4,824.92	
<u>Modular Trim</u>	<u>14629-1P</u>	<u>14630-1P</u>	N/A	<u>14631-1P</u>	<u>14632-1P</u>	<u>14633-1P</u>	N/A
(incl. accessory pkg-09316)	\$5,105.93	\$4,929.83		\$5,005.47	\$5,218.93	\$5,230.21	

	1-1/2"	2"	2-1/2"	3"	4"	6"	8"
--	--------	----	--------	----	----	----	----

Releasing Devices (IPG V226)

<u>Pneumatic Actuator</u>	<u>06459B</u>	<u>06459B</u>	<u>06459B</u>	<u>06459B</u>	<u>06459B</u>	<u>06459B</u>	<u>06459B</u>
	\$866.99	\$866.99	\$866.99	\$866.99	\$866.99	\$866.99	\$866.99

Releasing Trim - Galvanized (IPG V238)

<u>Loose Trim</u>	<u>10809</u>	<u>10809</u>	<u>10809</u>	<u>10809</u>	<u>10809</u>	<u>10809</u>	<u>10809</u>
(releasing device not incl.)	\$135.84	\$135.84	\$135.84	\$135.84	\$135.84	\$135.84	\$135.84
<u>Modular Trim</u>	<u>10809P</u>	<u>10809P</u>	<u>10809P</u>	<u>10809P</u>	<u>10809P</u>	<u>10809P</u>	<u>10809P</u>
(releasing device not incl.)	\$605.38	\$605.38	\$605.38	\$605.38	\$605.38	\$605.38	\$605.38
<u>Loose Trim-DOMESTIC¹</u>	<u>10809USA</u>	<u>10809USA</u>	<u>10809USA</u>	<u>10809USA</u>	<u>10809USA</u>	<u>10809USA</u>	<u>10809USA</u>
(releasing device not incl.)	\$181.12	\$181.12	\$181.12	\$181.12	\$181.12	\$181.12	\$181.12

Trim packages includes deluge valve accessory package (p/n 09316) - See page N-7 for package detail.

See pages N-11/N-12 for additional valve and trim options, including Halar® coated valves, domestic trim, horizontal trim, brass trim packages.

(1) Meets sourcing requirements of the Buy American Act, American Reinvestment and Recovery Act, and Buy American Law.

Deluge System - Hydraulic Release

Straight-through valve shown.

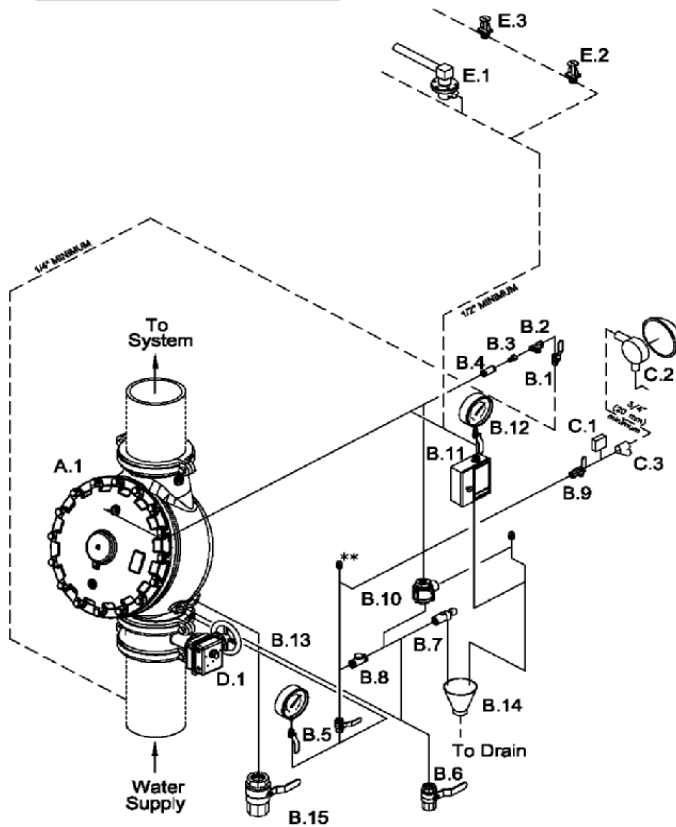

SYSTEM COMPONENTS

- A. Valve**
 - A.1 Deluge Valve
- B. Deluge Valve Conventional Trim ***
(See Deluge Valve Conventional Trim Charts)
 - B.1 Priming Valve (Normally Open)
 - B.2 Strainer
 - B.3 1/16" Restriction
 - B.4 Spring Loaded Check Valve
 - B.5 Alarm Test Valve (Normally Closed)
 - B.6 Auxiliary Drain Valve (Normally Closed)
 - B.7 Drip Check Valve
 - B.8 Drain Check Valve
 - B.9 Alarm Shut-Off Valve (Normally Open)
 - B.10 Pressure Operated Relief Valve (P.O.R.V.)
 - B.11 Emergency Release
 - B.12 Priming Pressure Water Gauge and Valve
 - B.13 Water Supply Pressure Gauge and Valve
 - B.14 Drain cup
 - B.15 Flow Test Valve (Normally Closed)
- C. Water Flow Alarm Equipment**
 - C.1 Alarm Pressure Switch and/or
 - C.2 Water Motor Alarm (Strainer Required)
 - C.3 Strainer
- D. Riser**
 - D.1 Water Supply Control Valve
- E. Release System**
 - E.1 Thermostatic Release and/or
 - E.2 Fixed Temperature Release and/or
 - E.3 Pilot Head (Sprinkler)

CAUTION

DO NOT EXCEED MAXIMUM HEIGHT ALLOWED FOR THE HYDRAULIC RELEASE PIPING ABOVE THE DELUGE VALVE.

FOR MAXIMUM HEIGHT ALLOWED, REFER TO CURRENT TECHNICAL DATA DESCRIBING THE VIKING DELUGE VALVE USED.

--- Dashed lines indicate pipe required but not included with Deluge Valve Conventional Trim Packages.

- * Viking Deluge Valve Trim Packages contain items B.1 through B.15 and associated nipples. Viking Accessory Package for Conventional Deluge Valve Trim contains B.2 through B.5, B.7 through B.11, and B.14.
- ** 1/2" (15 mm) NPT for Non-Interruptable Alarm Pressure Switch (Optional)

Components shown above are included in Quik Pik packages as customized by user. See page N-4.

Model F Deluge / Preaction Valve* - STRAIGHT THROUGH

V233	1-1/2"	2"	2-1/2"	3"	4"	6"	8"
Thread X Thread	<u>12126</u> \$4,027.62	<u>12059</u> \$4,162.89	<u>12401</u> \$5,497.16	N/A	N/A	N/A	N/A
Flange X Flange	N/A	N/A	N/A	<u>12014</u> \$5,497.16	<u>11953</u> \$7,160.55	<u>11955</u> \$9,794.34	<u>11991</u> \$22,185.37
Flange X Groove	N/A	N/A	N/A	<u>12018</u> \$5,497.16	<u>11952</u> \$7,160.55	<u>11954</u> \$9,794.34	N/A
Groove X Groove	<u>12125</u> \$4,027.62	<u>12057</u> \$4,162.89	<u>12403</u> \$5,497.16	<u>12022</u> \$5,497.16	<u>11513</u> \$7,160.55	<u>11524</u> \$9,794.34	<u>11018</u> \$22,185.37

See page N-11/12 for additional valve and trim options, including Halar® coated valves, horizontal trim, and brass trim packages.

* Valve is not included in trim packages. Please order separately. See following page for trim packages and equipment.

Deluge System - Hydraulic Release

	1-1/2"	2"	2-1/2"	3"	4"	6"	8"
Trim (Vertical - Straight Through Valve) - Galvanized (IPG V236)							
<u>Loose Trim</u> <i>(incl. accessory pkg-09316)</i>	<u>14634-1</u> \$4,488.91	<u>14634-1</u> \$4,488.91	<u>14636-1</u> \$4,392.98	<u>14636-1</u> \$4,392.98	<u>14639-1</u> \$4,596.80	<u>14641-1</u> \$4,607.59	<u>14642-1</u> \$6,674.29
<u>Modular Trim</u> <i>(incl. accessory pkg-09316)</i>	<u>14634-1P</u> \$4,894.21	<u>14634-1P</u> \$4,894.21	<u>14636-1P</u> \$4,798.23	<u>14636-1P</u> \$4,798.23	<u>14639-1P</u> \$5,003.98	<u>14641-1P</u> \$5,014.73	<u>14642-1P</u> \$7,081.44

Trim packages includes deluge valve accessory package (p/n 09316) - See page N-7 for package detail.
 See pages N-11/12 for additional valve and trim options, including Halar® coated valves, horizontal trim, domestic trim, and brass trim packages.

Deluge System - Electric Release

Straight-through valve shown

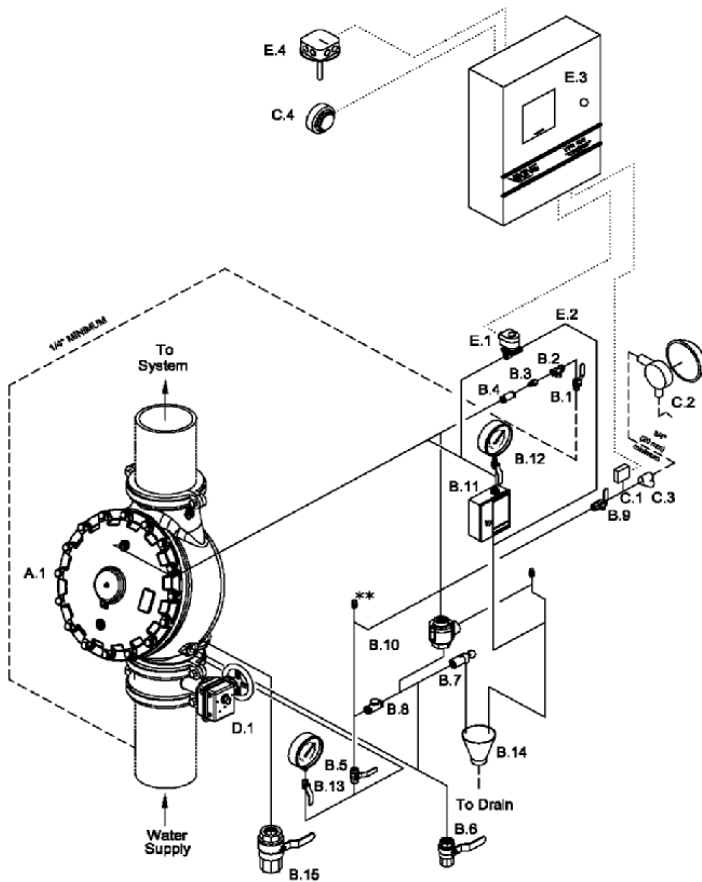

SYSTEM COMPONENTS

- A. Valve**
 - A.1 Deluge Valve
- B. Deluge Valve Conventional Trim ***
(See Deluge Valve Conventional Trim Charts)
 - B.1 Priming Valve
 - B.2 Strainer
 - B.3 1/16" Restricted Orifice
 - B.4 Spring Loaded Check Valve
 - B.5 Alarm Test Valve (Normally Closed)
 - B.6 Auxiliary Drain Valve (Normally Closed)
 - B.7 Drip Check Valve
 - B.8 Drain Check Valve
 - B.9 Alarm Shut-Off Valve (Normally Open)
 - B.10 Pressure Operated Relief Valve (P.O.R.V.)
 - B.11 Emergency Release
 - B.12 Priming Pressure Water Gauge and Valve
 - B.13 Water Supply Pressure Gauge and Valve
 - B.14 Drain Cup
 - B.15 Flow Test Valve (Normally Closed)
- C. Water Flow Alarm Equipment**
 - C.1 Alarm Pressure Switch and/or
 - C.2 Water Motor Alarm (Strainer Required)
 - C.3 Strainer
 - C.4 Electric Alarm Bell
- D. Riser**
 - D.1 Water Supply Control Valve
- E. Release System**
 - E.1 Solenoid Valve
 - E.2 Electric Release Module Trim
 - E.3 System Control Panel configured for Single Zone Deluge operation.
 - E.4 Electric Detection System. Heat Detector shown for clarity.

----- Dashed lines indicate pipe required but not listed in "System Components" Table.

* Viking Deluge Valve Trim Packages contain items B.1 through B.15 and associated nipples. Viking Accessory Package for Conventional Deluge Valve Trim contains B.2 through B.5, B.7 through B.11, and B.14.

..... Dotted lines indicate electrical detection system wiring required but not listed in "System Components" Table. For additional wiring requirements refer to technical data for components used.

Components shown above are included in Quik Pik packages as customized by user. See page N-6.

Model F Deluge / Preaction Valve* - STRAIGHT THROUGH

V233	1-1/2"	2"	2-1/2"	3"	4"	6"	8"
Thread X Thread	<u>12126</u> \$4,027.62	<u>12059</u> \$4,162.89	<u>12401</u> \$5,497.16	N/A	N/A	N/A	N/A
Flange X Flange	N/A	N/A	N/A	<u>12014</u> \$5,497.16	<u>11953</u> \$7,160.55	<u>11955</u> \$9,794.34	<u>11991</u> \$22,185.37
Flange X Groove	N/A	N/A	N/A	<u>12018</u> \$5,497.16	<u>11952</u> \$7,160.55	<u>11954</u> \$9,794.34	N/A
Groove X Groove	<u>12125</u> \$4,027.62	<u>12057</u> \$4,162.89	<u>12403</u> \$5,497.16	<u>12022</u> \$5,497.16	<u>11513</u> \$7,160.55	<u>11524</u> \$9,794.34	<u>11018</u> \$22,185.37

See page N-11/12 for additional valve and trim options, including Halar® coated valves, horizontal trim, and brass trim packages.

* Valve is not included in trim packages. Please order separately. See following page for trim packages and equipment.

Deluge System - Electric Release

TrimPac® IPG V234	1-1/2"	2"	2-1/2"	3"	4"	6"	8"
<u>Straight-Through</u>	13787B-1	13787B-1	13787B-1	13787B-1	13787B-1	13787B-1	13787B-1
	\$7,152.00	\$7,152.00	\$7,152.00	\$7,152.00	\$7,152.00	\$7,152.00	\$7,152.00

TrimPac® includes conventional trim, releasing device (solenoid valve), releasing trim, and flexible hose kit.
Drain package for TrimPac® must be ordered separately (see below).

Drain Package (IPG V257)

Use with TrimPac® (order separately)	11894-1	11894-2	11894-3	11894-3	11894-4	11894-4	11894-4
	\$738.33	\$597.20	\$676.78	\$676.78	\$868.61	\$868.61	\$868.61

1-1/2"	2"	2-1/2"	3"	4"	6"	8"
--------	----	--------	----	----	----	----

Trim (Vertical - Straight Through Valve) - Galvanized (IPG V236)

<u>Loose Trim</u> (incl. accessory pkg-09316)	14634-1	14634-1	14636-1	14636-1	14639-1	14641-1	14642-1
	\$4,488.91	\$4,488.91	\$4,392.98	\$4,392.98	\$4,596.80	\$4,607.59	\$6,674.29
<u>Modular Trim</u> (incl. accessory pkg-09316)	14634-1P	14634-1P	14636-1P	14636-1P	14639-1P	14641-1P	14642-1P
	\$4,894.21	\$4,894.21	\$4,798.23	\$4,798.23	\$5,003.98	\$5,014.73	\$7,081.44

Trim (Vertical - Angle Style Valve) - Galvanized (IPG V236)

<u>Loose Trim</u> (incl. accessory pkg-09316)	14629-1	14630-1	N/A	14631-1	14632-1	14633-1	N/A
	\$4,700.66	\$4,524.53		\$4,600.19	\$4,813.68	\$4,824.92	
<u>Modular Trim</u> (incl. accessory pkg-09316)	14629-1P	14630-1P	N/A	14631-1P	14632-1P	14633-1P	N/A
	\$5,105.93	\$4,929.83		\$5,005.47	\$5,218.93	\$5,230.21	

1-1/2"	2"	2-1/2"	3"	4"	6"	8"
--------	----	--------	----	----	----	----

Releasing Devices (IPG V240)

<u>Solenoid Valve</u>	11601	11601	11601	11601	11601	11601	11601
	\$1,345.64	\$1,345.64	\$1,345.64	\$1,345.64	\$1,345.64	\$1,345.64	\$1,345.64

Releasing Trim - Galvanized (IPG V238)

<u>Loose Trim</u> (releasing device not incl.)	10830	10830	10830	10830	10830	10830	10830
	\$140.24	\$140.24	\$140.24	\$140.24	\$140.24	\$140.24	\$140.24
<u>Modular Trim</u> (releasing device not incl.)	10830P	10830P	10830P	10830P	10830P	10830P	10830P
	\$605.38	\$605.38	\$605.38	\$605.38	\$605.38	\$605.38	\$605.38
<u>Loose Trim-DOMESTIC¹</u> (releasing device not incl.)	10830USA	10830USA	10830USA	10830USA	10830USA	10830USA	10830USA
	\$186.96	\$186.96	\$186.96	\$186.96	\$186.96	\$186.96	\$186.96

Trim packages includes deluge valve accessory package (p/n 09316) - See page N-7 for package detail.

See pages N-11/N-12 for additional valve and trim options, including Halar® coated valves, horizontal trim, domestic trim, and brass trim packages.

(1) Meets sourcing requirements of the Buy American Act, American Reinvestment and Recovery Act, and Buy American Law.

Accessories and Additional Components

Deluge Valve Accessory Package

(use with straight through valves)

(included with deluge/preaction trim)

Includes:

- 1/16" Restricted Orifice Galvanized
- Emergency Release 09316
- Drip Check \$3,102.90
- 1/4" / 8mm Check Valve
- 1/4" / 8mm Strainer Stainless Steel *
- Drain Cup 09743
- PORV \$4,327.71
- Drain Check * Does not include PORV
- 1/2" Ball Valve IPG V226

Speed Control Assembly

(use with trim to control speed of valve opening)

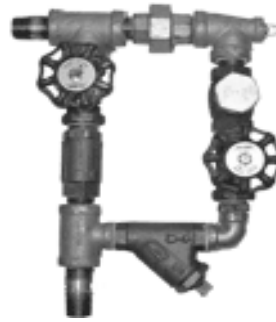

- Galvanized
- 08780 \$2,219.48
- Stainless Steel
- 11192 \$13,060.54
- Brass
- 11181 \$2,615.07

IPG V244

Pressure Operated Relief Valve (PORV) - Model D-3



- 1/2" / DN15
- Brass
- 16970 \$2,024.12

IPG V242

Pressure Operated Relief Valve (PORV) - Model D-4



- 1/2" / DN15
- Corrosion Resistant
- 16971 \$3,114.04

IPG V242

Globe Valve for Gauges (side outlet)



- 1/4" / DN8
- 76V-25 \$26.52

Restricted Orifice

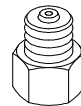

- 1/4" (DN8)
- 1/16" (1.6mm) 10110 \$52.41
- Corrosion Resistant
- 1/16" (1.6mm) 10110J \$122.16

IPG V226

Ball Valve

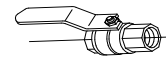

IPG V226

<u>Brass</u>			<u>Stainless Steel</u>	
1/4"	0354US	\$46.60	10644	\$372.50
1/2"	0355US	\$46.60	10645	\$374.63
1"	10356	\$106.25	10646	\$597.54
			10647	\$724.32
			10648	\$1,380.7
			10649	\$1,874.1

Drain Check Valve

IPG V226

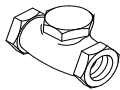

- 1/2" / DN15
- 05781A \$134.80
- Corrosion Resistant
- 05781AJ \$282.00

Drain Cup



- 1/2" / DN40
- 01019B \$25.94

IPG V226

Emergency Release

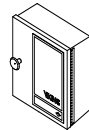

1/2" (Galvanized)		<u>Brass</u>		<u>Corrosion Resistant</u>	
<u>Model C-1</u>		<u>Model C-2</u>		<u>Model C-3</u>	
01553C	\$517.81	09387	\$863.74	09734	\$1,059.68

IPG V226

Prime Shut-Off Valve

IPG V226

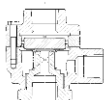

- 1/2" / DN15
- 10723 \$1,146.89
- Corrosion Resistant
- 10724 \$2,049.98

Drip Check Valve - Model D-1



- Velocity Check 3/4" / DN20
- 10730 \$264.89
- Corrosion Resistant
- IPG V25.1 10733 \$399.55

Water Gauge



- 0-300 psi
- 1/4" VWATERSF \$29.92

In-Line Check Valve

IPG V226

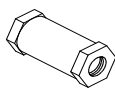

- 1/4" / DN8
- 04947A \$125.39

Y Strainer

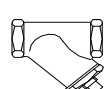

- 1/4" / DN15
- 14BYS \$41.13

IPG SR260

Restricted Orifice



- 5/64" / 2mm
- 1/2" / DN15
- 11706 \$108.25

IPG V226

Accessories for TrimPac®

Air Line Trim

(not for use with Deluge TrimPac System)

- Tank Mounted 13770 \$2,470.23
- Tankless 13771 \$870.94

IPG V234

Replacement Hose

- PVC drain hose 12071 \$196.74

IPG V234

Riser Mounting Kit

(when mounting TrimPac to riser)

- Vertical 11900 \$1,366.22
- Horizontal 11901 \$1,878.64

IPG V234

Accessories for Old Style Trim

Model A-2 Strainer Orifice Check Vlv

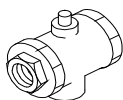

- 1/4" (DN8)
- 06579B \$492.32

IPG V226

Alarm Test/Alarm Shut-Off Valve

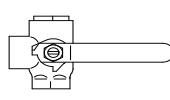

- 1/2" (DN15)
- 06174A \$530.09

IPG V226

Spring Loaded Check Valve

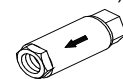

(with viton disc)







- 1/2" (DN15)
- 12WILC \$272.59

SR140

Accessories for Pneumatic Release Systems

<p>Pneumatic Actuator</p>  <p>1/2" (DN15) Model H-1 06459B \$866.99 Corrosion Resistant (Model R-1) 09733 \$1,955.91</p> <p style="text-align: right;">IPG V226</p>	<p>Accelerator (Model E-1)</p>  <p>Model E-1 List 08055 \$2,143.90</p> <p style="text-align: right;">IPG V226</p>																					
<p>Model D-2 - Air Pressure Maintenance Device</p>  <table border="1"> <thead> <tr> <th>Size</th> <th>Part #</th> <th>List Price</th> </tr> </thead> <tbody> <tr> <td>1/4" / DN8</td> <td>02280C</td> <td>\$1,023.63</td> </tr> </tbody> </table> <p style="text-align: right;">IPG V226</p>	Size	Part #	List Price	1/4" / DN8	02280C	\$1,023.63	<p>Model D-2 - Air Pressure Maintenance Device</p>  <table border="1"> <thead> <tr> <th>Size</th> <th>Part #</th> <th>List Price</th> </tr> </thead> <tbody> <tr> <td>1/2" / DN15</td> <td>07459</td> <td>\$1,798.81</td> </tr> <tr> <td colspan="3">DOMESTIC</td> </tr> <tr> <th>Size</th> <th>Part #</th> <th>List Price</th> </tr> <tr> <td>1/2" / DN15</td> <td>07459USA</td> <td>\$2,398.40</td> </tr> </tbody> </table> <p style="text-align: right;">IPG V226</p>	Size	Part #	List Price	1/2" / DN15	07459	\$1,798.81	DOMESTIC			Size	Part #	List Price	1/2" / DN15	07459USA	\$2,398.40
Size	Part #	List Price																				
1/4" / DN8	02280C	\$1,023.63																				
Size	Part #	List Price																				
1/2" / DN15	07459	\$1,798.81																				
DOMESTIC																						
Size	Part #	List Price																				
1/2" / DN15	07459USA	\$2,398.40																				
<p>Dehydrator Package</p> <p>Includes:</p> <ul style="list-style-type: none"> - Desiccant - Mounting Brackets - Nipples <table border="1"> <thead> <tr> <th>Size</th> <th>Part #</th> <th>List Price</th> </tr> </thead> <tbody> <tr> <td>1/4" (DN8)</td> <td>16854</td> <td>\$2,421.97</td> </tr> <tr> <td>Extra Desiccant*</td> <td>16855</td> <td>\$548.37</td> </tr> </tbody> </table> <p style="text-align: right;">IPG V226</p> <p>*one unit fills dehydrator</p>	Size	Part #	List Price	1/4" (DN8)	16854	\$2,421.97	Extra Desiccant*	16855	\$548.37	<p>Replacement Restriction</p> <p>Release Line Air Supply</p>  <table border="1"> <thead> <tr> <th>Part #</th> <th>List Price</th> </tr> </thead> <tbody> <tr> <td>02902B</td> <td>\$248.01</td> </tr> </tbody> </table> <p style="text-align: right;">IPG V226</p>	Part #	List Price	02902B	\$248.01								
Size	Part #	List Price																				
1/4" (DN8)	16854	\$2,421.97																				
Extra Desiccant*	16855	\$548.37																				
Part #	List Price																					
02902B	\$248.01																					

Accessories for Pneumatic and Hydraulic Systems

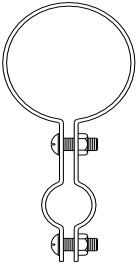
<p>Thermostatic Release (Model C-1)</p> <p>(Includes 155°F/68°C fixed temperature release)</p> <p>- indoor and outdoor use</p>  <table border="1"> <thead> <tr> <th>Standard</th> <th>Part #</th> <th>List Price</th> </tr> </thead> <tbody> <tr> <td></td> <td>01432C</td> <td>\$2,293.21</td> </tr> <tr> <td>Nitrogen Tested</td> <td>05006A</td> <td>\$2,470.35</td> </tr> </tbody> </table> <p style="text-align: right;">IPG V226</p>	Standard	Part #	List Price		01432C	\$2,293.21	Nitrogen Tested	05006A	\$2,470.35	<p>Thermostatic Release (Model C-2)</p> <p>(Includes 155°F/68°C fixed temperature release)</p> <p>- indoor and outdoor use</p> <p>- corrosion resistant</p> <p>- for use in salt water environments</p> <table border="1"> <thead> <tr> <th>Standard</th> <th>Part #</th> <th>List Price</th> </tr> </thead> <tbody> <tr> <td></td> <td>03991C-18</td> <td>\$2,728.86</td> </tr> <tr> <td>Nitrogen Tested</td> <td>10367</td> <td>\$2,906.02</td> </tr> </tbody> </table> <p style="text-align: right;">IPG V226</p>	Standard	Part #	List Price		03991C-18	\$2,728.86	Nitrogen Tested	10367	\$2,906.02																					
Standard	Part #	List Price																																						
	01432C	\$2,293.21																																						
Nitrogen Tested	05006A	\$2,470.35																																						
Standard	Part #	List Price																																						
	03991C-18	\$2,728.86																																						
Nitrogen Tested	10367	\$2,906.02																																						
<p>Operation Indicator</p> <p>Includes:</p> <p>- indoor and outdoor use</p> <p>- corrosion resistant</p> <table border="1"> <thead> <tr> <th>1/2" (DN15)</th> <th>Part #</th> <th>List Price</th> </tr> </thead> <tbody> <tr> <td></td> <td>02944A</td> <td>\$89.97</td> </tr> </tbody> </table> <p style="text-align: right;">IPG V226</p>	1/2" (DN15)	Part #	List Price		02944A	\$89.97	<p>Adjustment Kit</p> <p>Includes:</p> <p>- indoor and outdoor use</p> <p>- corrosion resistant</p>  <p>Model C-1 and C-2 01714A \$274.18</p> <p style="text-align: right;">IPG V226</p>																																	
1/2" (DN15)	Part #	List Price																																						
	02944A	\$89.97																																						
<p>Fixed Temperature Release (Model M HP - VK800)</p> <p>1/2" (15 mm) - RATED TO 250 PSI (1724 kPa)</p>  <table border="1"> <thead> <tr> <th>Material</th> <th>Part #</th> <th>List Price</th> </tr> </thead> <tbody> <tr> <td>Brass</td> <td>07848AB</td> <td>\$72.74</td> </tr> <tr> <td>Chrome</td> <td>07848FA</td> <td>\$77.98</td> </tr> <tr> <td>White</td> <td>07848MA/W</td> <td>\$77.98</td> </tr> </tbody> </table> <p style="text-align: right;">IPG V226</p> <p>Add the temperature suffix to the part number (135 shown): (°F/°C) A=135°/57°, B=155°/68°, D=175°/79°, E=200°/93°, G=286°/141°</p>	Material	Part #	List Price	Brass	07848AB	\$72.74	Chrome	07848FA	\$77.98	White	07848MA/W	\$77.98	<p>Replacement Fixed Temperature Release</p> <p>155°F/68°C</p>  <table border="1"> <thead> <tr> <th>Model</th> <th>Part #</th> <th>List Price</th> </tr> </thead> <tbody> <tr> <td>Model C-1</td> <td>07848FB</td> <td>\$77.98</td> </tr> <tr> <td>Model C-2</td> <td>07848CB</td> <td>\$92.98</td> </tr> </tbody> </table> <p style="text-align: right;">IPG V226</p>	Model	Part #	List Price	Model C-1	07848FB	\$77.98	Model C-2	07848CB	\$92.98																		
Material	Part #	List Price																																						
Brass	07848AB	\$72.74																																						
Chrome	07848FA	\$77.98																																						
White	07848MA/W	\$77.98																																						
Model	Part #	List Price																																						
Model C-1	07848FB	\$77.98																																						
Model C-2	07848CB	\$92.98																																						
<p>Release Line Hangers</p>  <p>- includes two screws/nuts</p> <table border="1"> <thead> <tr> <th>Size</th> <th>Part #</th> <th>List Price</th> </tr> </thead> <tbody> <tr> <td>1" / DN25</td> <td>09574</td> <td>\$30.64</td> </tr> <tr> <td>1 1/4" / DN32</td> <td>09575</td> <td>\$30.64</td> </tr> <tr> <td>1 1/2" / DN40</td> <td>09576</td> <td>\$30.64</td> </tr> <tr> <td>2" / DN50</td> <td>09577</td> <td>\$30.64</td> </tr> <tr> <td>2 1/2" / DN65</td> <td>09578</td> <td>\$30.64</td> </tr> <tr> <td>3" / DN80</td> <td>09579</td> <td>\$30.64</td> </tr> </tbody> </table> <table border="1"> <thead> <tr> <th>Size</th> <th>Part #</th> <th>List Price</th> </tr> </thead> <tbody> <tr> <td>3 1/2" / DN90</td> <td>09580</td> <td>\$30.64</td> </tr> <tr> <td>4" / DN100</td> <td>09581</td> <td>\$44.80</td> </tr> <tr> <td>5" / DN125</td> <td>09582</td> <td>\$44.80</td> </tr> <tr> <td>6" / DN150</td> <td>09583</td> <td>\$44.80</td> </tr> <tr> <td>8" / DN200</td> <td>09584</td> <td>\$44.80</td> </tr> </tbody> </table> <p style="text-align: right;">IPG V226</p> <p>Stainless steel available upon request at additional cost. Add suffix "SST" to base part number.</p>		Size	Part #	List Price	1" / DN25	09574	\$30.64	1 1/4" / DN32	09575	\$30.64	1 1/2" / DN40	09576	\$30.64	2" / DN50	09577	\$30.64	2 1/2" / DN65	09578	\$30.64	3" / DN80	09579	\$30.64	Size	Part #	List Price	3 1/2" / DN90	09580	\$30.64	4" / DN100	09581	\$44.80	5" / DN125	09582	\$44.80	6" / DN150	09583	\$44.80	8" / DN200	09584	\$44.80
Size	Part #	List Price																																						
1" / DN25	09574	\$30.64																																						
1 1/4" / DN32	09575	\$30.64																																						
1 1/2" / DN40	09576	\$30.64																																						
2" / DN50	09577	\$30.64																																						
2 1/2" / DN65	09578	\$30.64																																						
3" / DN80	09579	\$30.64																																						
Size	Part #	List Price																																						
3 1/2" / DN90	09580	\$30.64																																						
4" / DN100	09581	\$44.80																																						
5" / DN125	09582	\$44.80																																						
6" / DN150	09583	\$44.80																																						
8" / DN200	09584	\$44.80																																						

Accessories for Electric Release Systems

SOLENOID VALVES (1/2" / DN15) IPG V240

Normally Closed (rated to 250 psi (1724 kPa))



			<u>Part No.</u>	<u>List Price</u>
<u>Deluge & Preaction, SureFire</u>				
NEMA 1,2,3,3S,4,4X	24 VDC		11601	\$1,345.64
<u>Explosion Proof</u>				
NEMA 3,3S,4,4X,6,6P,7,9	24 VDC		11602	\$2,248.90

Normally Closed (rated to 300 psi (2068 kPa))



<u>Firecycle III, TotalPac & Special Application</u>				
NEMA 2,3,3S,4,4X	24 VDC		11591	\$1,718.09
NEMA 1,2,3,3S,4,4X	110 VAC/50 HZ		11593	\$1,461.98
NEMA 1,2,3,3S,4,4X	120 VAC/60 HZ		11594	\$1,988.14
<u>Explosion Proof</u>				
NEMA 3,3S,4,4X,6,6P,7,9	24 VDC		11592	\$2,248.90
NEMA 3,3S,4,4X,6,6P,7,9	110 VAC/50 HZ		11594	\$1,988.14
NEMA 3,3S,4,4X,6,6P,7,9	120 VAC/60 HZ		11594	\$1,988.14
ATEX, EEx, mII, T4/T5	110 VAC/50 HZ		12359	\$2,360.56
ATEX, EEx, mII, T4/T5	24 VDC		12360	\$2,621.35

Normally Open (rated to 300 psi (2068 kPa))



<u>Firecycle III</u>				
NEMA 2,3,3S,4,4X	24 VDC		11595	\$2,858.84
<u>Surefire & TrimPac</u>				
NEMA 2,3,3S,4,4X	24 VDC		13215	\$2,858.84
<u>Explosion Proof</u>				
NEMA 3,3S,4,4X,6,6P,7,9	24 VDC		11596	\$3,985.58
ATEX, EEx, mII, T4/T5	24 VDC		12358	\$4,357.96

RELEASE CONTROL PANEL (VFR-500) IPG V241

VFR-500 Release Control Panel

- Contains seven user-definable zones & menu-driven programming controls
 - Up to 35 standard programs in memory and programmable cross-zoning
 - Multi-directional navigation through the panel history and menus
 - cULus Listed and FM Approved for agent and/or water-based extinguishing
- * see below for accessories and optional modules

<u>Part No.</u>	<u>List Price</u>
26107	\$5,790.17



Optional Modules / Accessories Batteries (two required per panel)

	<u>Part No.</u>	<u>List Price</u>
CA2Z Module (class A initiating device circuit):	14155	\$334.42
CAM2 Module (class A indicating appliance circuit):	14156	\$384.58
ARM-1/ARM-2 Module (auxiliary relay module):	14157	\$484.91
RA-4410-RC (remote annunciator):	14154	\$1,755.69
	<u>Part No.</u>	<u>List Price</u>
MR-101/T SPDT Relay Module:	14159	\$196.50
MR-201 DPDT Relay Module:	14160	\$246.62
MR801/T SPDT Relay w/Led Indicator:	14161	\$104.51
ELOD Resistor/Diode:	14162	\$50.16
ELOR Resistor:	14163	\$4.20



	<u>Part No.</u>	<u>List Price</u>
8 Amp	07920	P.O.A.
12 Amp	07921	P.O.A.
18 Amp	09867	P.O.A.

Battery Cabinet (for 18 amp hr battery)

<u>Part No.</u>	<u>List Price</u>
09866	\$978.85

Alarm Devices

Alarm Pressure Switch - SR020

<u>Adjustable Range (4-20 psi)</u> 1/2" / DN50 Single SPDT PS101A \$269.05 Dual SPDT PS102A \$324.36  * Manufactured by Potter			<u>Explosion Proof</u> Dual SPDT PS10-EX \$1,894.79 Dual SPDT PS40EX \$1,894.79 * Cenelec approved <u>Pressure Adj Access Key</u> 10600 \$38.42 <u>Cover Removal Key</u> 10601 \$38.42 		
---	--	--	--	--	--

* Appropriate hex keys included with switches.

Pressure Supervisory Switch (Air, Nitrogen, Water) - IPG SR020





<u>Adjustable Range (10-175 psi)</u> 1/2" / DN50 Single SPDT PS401A \$269.05 Dual SPDT PS402A \$324.36  * Manufactured by Potter <u>Cover Tamper Switch Kit</u> 09601 \$196.51			<u>Explosion Proof</u>  <u>Pressure Adj Access Key</u> 10600 \$38.42 <u>Cover Removal Key</u> 10601 \$38.42		
---	--	--	---	--	--

* Appropriate hex keys included with switches.

Flow Switch - SR010

<u>Waterflow Indicators</u> (adjustable retard up to 120 sec. - 2 SPDT contacts) <u>Model VSR</u> 1-2" / DN40 VSRF0100 \$390.46 2" / DN50 VSRF0200 \$422.48 2½" / DN65 VSRF0250 \$422.48 3" / DN80 VSRF0300 \$422.48 3½" / DN90 VSRF0350 \$422.48 4" / DN100 VSRF0400 \$422.48 5" / DN125 VSRF0500 \$422.48 6" / DN150 VSRF0600 \$422.48 8" / DN200 VSRF0800 \$473.72 		
--	--	--

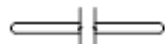
Water Motor Alarm and Accessories - IPG V226

<u>Water Motor Alarm</u>  Model F-2 07862 \$873.25		<u>Closure Plate</u>  05820B \$178.23	
<u>Adjustable Shaft</u> (wall thickness up to 30-1/4 in / 768 mm)  03312B \$171.00		<u>Alarm Line Y Strainer</u>  3/4" (DN20) 01489A \$260.03	
<u>Extension Cup</u>  05957B \$142.59			

Special Valves and Trim

HALAR® Coated Deluge / Preaction Valves (Model F-2)

Straight-Through (Model F-2)

IPG V233	1-1/2"	2"	2-1/2"	3"	4"	6"	8"
Thread X Thread	N/A	N/A	<u>12402Q/B</u> \$8,612.28	N/A	N/A	N/A	N/A
Flange X Flange	N/A	N/A	N/A	<u>12015Q/B</u> \$8,612.28	<u>11960Q/B</u> \$11,522.52	<u>11962Q/B</u> \$15,418.86	<u>11992Q/B</u> \$32,278.39
Flange X Groove	N/A	N/A	N/A	<u>12019Q/B</u> \$8,612.28	<u>11959Q/B</u> \$11,522.52	<u>11961Q/B</u> \$15,418.86	N/A
Groove X Groove	<u>12127Q/B</u> \$6,380.79	<u>12058Q/B</u> \$6,398.15	<u>12404Q/B</u> \$8,612.28	<u>12023Q/B</u> \$8,612.28	<u>11514Q/B</u> \$11,522.52	<u>11525Q/B</u> \$15,418.86	<u>11118Q/B</u> \$30,719.06

HORIZONTAL TRIM - Conventional Deluge / Preaction Trim

Galvanized (use with straight through valves)

IPG V236	1-1/2"	2"	2-1/2"	3"	4"	6"	8"
<u>Loose Trim</u> (incl. accessory pkg-09316)	<u>14635-1</u> \$4,488.91	<u>14635-1</u> \$4,488.91	<u>14637-1</u> \$4,392.98	<u>14637-1</u> \$4,392.98	<u>14638-1</u> \$4,596.80	<u>14640-1</u> \$4,607.59	<u>14643-1</u> \$6,674.29
<u>Modular Trim</u> (incl. accessory pkg-09316)	<u>14635-1P</u> \$4,894.21	<u>14635-1P</u> \$4,894.21	<u>14637-1P</u> \$4,798.23	<u>14637-1P</u> \$4,798.23	<u>14638-1P</u> \$5,003.98	<u>14640-1P</u> \$5,014.73	<u>14643-1P</u> \$7,081.44

* Galvanized vertical trim found on page N-6.

BRASS TRIMS - Conventional Deluge / Preaction Trim

Angle Style Valves

IPG V237	1-1/2"	2"	2-1/2"	3"	4"	6"	8"
<u>Loose Trim</u> (incl. accessory pkg-09316)	<u>14629-2</u> \$7,978.83	<u>14630-2</u> \$7,399.73	N/A	<u>14631-2</u> \$7,577.89	<u>14632-2</u> \$8,097.08	<u>14633-2</u> \$8,190.51	N/A
<u>Modular Trim</u> (incl. accessory pkg-09316)	<u>14629-2P</u> P.O.A.	<u>14630-2P</u> \$7,827.15	N/A	<u>14631-2P</u> P.O.A.	<u>14632-2P</u> \$8,524.48	<u>14633-2P</u> \$8,618.02	N/A

Straight Through Valves - VERTICAL

IPG V237	1-1/2"	2"	2-1/2"	3"	4"	6"	8"
<u>Loose Trim</u> (incl. accessory pkg-09316)	<u>14634-2</u> \$7,619.45	<u>14634-2</u> \$7,619.45	<u>14636-2</u> \$7,236.54	<u>14636-2</u> \$7,236.54	<u>14639-2</u> \$7,732.33	<u>14641-2</u> \$7,821.58	<u>14642-2</u> \$9,745.79
<u>Modular Trim</u> (incl. accessory pkg-09316)	<u>14634-2P</u> \$8,046.95	<u>14634-2P</u> \$8,046.95	<u>14636-2P</u> \$7,664.04	<u>14636-2P</u> \$7,664.04	<u>14639-2P</u> \$8,159.83	<u>14641-2P</u> \$8,249.06	<u>14642-2P</u> \$10,152.94

Straight Through Valves - HORIZONTAL

IPG V237	1-1/2"	2"	2-1/2"	3"	4"	6"	8"
<u>Loose Trim</u> (incl. accessory pkg-09316)	<u>14635-2</u> \$7,619.45	<u>14635-2</u> \$7,619.45	<u>14637-2</u> \$7,236.54	<u>14637-2</u> \$7,236.54	<u>14638-2</u> \$7,732.33	<u>14640-2</u> \$7,821.58	<u>14643-2</u> \$9,745.79
<u>Modular Trim</u> (incl. accessory pkg-09316)	<u>14635-2P</u> \$8,046.95	<u>14635-2P</u> \$8,046.95	<u>14637-2P</u> P.O.A.	<u>14637-2P</u> P.O.A.	<u>14638-2P</u> P.O.A.	<u>14640-2P</u> \$8,249.06	<u>14643-2P</u> P.O.A.

Special Valves and Trim

BRASS - Releasing Trims

V239	Pneumatic	Electric Pneumatic	Electric	Pneumatic Pneumatic	DOMESTIC ¹ Electric
<u>Loose Trim</u> <i>(releasing device not incl.)</i>	<u>10811</u> \$370.11	<u>12661-2</u> \$308.95	<u>10832</u> \$416.45	<u>12662-2</u> \$1,971.20	<u>10832USA</u> \$555.26
<u>Modular Trim</u> <i>(releasing device not incl.)</i>	<u>10811P</u> \$809.80	<u>126612P</u> P.O.A.	<u>10832P</u> P.O.A.	<u>126622P</u> P.O.A.	<u>10832USA-P</u> P.O.A.

STAINLESS STEEL - Conventional Deluge Trim

Straight Through Valves - VERTICAL

V251	1-1/2"	2"	2-1/2"	3"	4"	6"	8"
<u>Loose Trim</u>	<u>14649</u> \$13,153.25	<u>14649</u> \$13,153.25	<u>14651</u> \$14,102.80	<u>14651</u> \$14,102.80	<u>14654</u> \$15,413.83	<u>14656</u> \$15,477.17	<u>14657</u> \$15,531.27
<u>Modular Trim</u>	<u>14649P</u> \$13,584.74	<u>14649P</u> \$13,584.74	<u>14651P</u> \$14,534.20	<u>14651P</u> \$14,534.20	<u>14654P</u> \$15,845.30	<u>14656P</u> \$15,908.64	<u>14657P</u> P.O.A.

DOMESTIC TRIM¹ - Model F - Galvanized

Straight Through Valves - VERTICAL

V236	1-1/2"	2"	2-1/2"	3"	4"	6"	8"
<u>Loose Trim</u>	<u>14634-1USA</u> \$5,985.21	<u>14634-1USA</u> \$5,985.21	<u>14636-1USA</u> \$5,857.31	<u>14636-1USA</u> \$5,857.31	<u>14639-1USA</u> \$6,129.11	<u>14641-1USA</u> \$6,143.44	<u>14642-1USA</u> \$8,899.05

(1) Meets sourcing requirements of the Buy American Act, American Reinvestment and Recovery Act, and the Buy American Law. Contact customer service for availability.

Deluge Valve Model VXD



VXD Deluge Valves - Pretrimmed Deluge Valves

Pre-trimmed Hydraulic Release Galvanized IPG V402

1-1/2"	2"	2-1/2"	3"	4"	6"	8"	10"
<u>23543</u>	<u>23575</u>	<u>23596</u>	<u>23617</u>	<u>23638</u>	<u>23660</u>	<u>23681</u>	<u>23702</u>
\$7,960.76	\$8,325.74	\$9,583.91	\$9,749.39	\$10,598.85	\$12,301.97	\$23,494.76	\$28,800.84

Pre-trimmed Pneumatic Release Galvanized IPG V402

1-1/2"	2"	2-1/2"	3"	4"	6"	8"	10"
<u>23549</u>	<u>23581</u>	<u>23602</u>	<u>23623</u>	<u>23644</u>	<u>23666</u>	<u>23687</u>	<u>23748</u>
\$9,170.62	\$9,535.59	\$10,606.30	\$10,771.78	\$11,679.14	\$13,324.15	\$24,858.45	\$30,192.99

Pre-trimmed Electric Release Galvanized IPG V402

1-1/2"	2"	2-1/2"	3"	4"	6"	8"	10"
<u>23546</u>	<u>23578</u>	<u>23599</u>	<u>23620</u>	<u>23641</u>	<u>23663</u>	<u>23684</u>	<u>23745</u>
\$9,237.83	\$9,602.80	\$10,860.97	\$11,026.45	\$11,875.93	\$13,579.07	\$24,771.86	\$30,077.90

VXD Deluge Valves - Loose Valve and Trim

Model VXD Deluge Valve - Groove/Groove IPG V400

1-1/2"	2"	2-1/2"	3"	4"	6"	8"	10"
<u>23310</u>	<u>23311</u>	<u>23312</u>	<u>23313</u>	<u>23316</u>	<u>23319</u>	<u>23322</u>	<u>23325</u>
\$3,152.23	\$3,554.41	\$4,930.64	\$5,113.00	\$5,952.42	\$7,821.95	\$18,104.68	\$23,454.10

Model VXD Deluge Valve - Flange/Flange IPG V400

3"	4"	6"	8"	10"
<u>23314</u>	<u>23317</u>	<u>23320</u>	<u>23323</u>	<u>23326</u>
\$5,113.00	\$5,952.42	\$7,821.95	\$18,104.68	\$23,454.10

Loose Trim Hydraulic Release Galvanized IPG V401

1-1/2"	2"	2-1/2"	3"	4"	6"	8"	10"
<u>23542-1</u>	<u>23574-1</u>	<u>23595-1</u>	<u>23616-1</u>	<u>23637-1</u>	<u>23659-1</u>	<u>23680-1</u>	<u>23701-1</u>
\$3,728.67	\$3,728.67	\$3,737.22	\$3,737.22	\$3,818.26	\$3,824.32	\$5,543.92	\$5,961.06

Loose Trim Pneumatic Release Galvanized IPG V401

1-1/2"	2"	2-1/2"	3"	4"	6"	8"	10"
<u>23548-1</u>	<u>23580-1</u>	<u>23601-1</u>	<u>23622-1</u>	<u>23643-1</u>	<u>23665-1</u>	<u>23686-1</u>	<u>23747-1</u>
\$4,846.41	\$4,846.41	\$4,867.21	\$4,867.21	\$4,907.00	\$4,913.28	\$6,803.75	\$7,247.22

Loose Trim Electric Release Galvanized IPG V401

1-1/2"	2"	2-1/2"	3"	4"	6"	8"	10"
<u>23545-1</u>	<u>23577-1</u>	<u>23598-1</u>	<u>23619-1</u>	<u>23640-1</u>	<u>23662-1</u>	<u>23683-1</u>	<u>23744-1</u>
\$4,908.50	\$4,908.50	\$4,917.05	\$4,917.05	\$4,998.09	\$5,004.15	\$6,723.76	\$7,140.89