



TECHNICAL DATA

MODEL VFM FOAM MAKERS

The Viking Corporation, 210 N Industrial Park Drive, Hastings MI 49058
 Telephone: 269-945-9501 Technical Services: 877-384-5464 Fax: 269-818-1680 Email: techsvcs@vikingcorp.com
 Visit the Viking website for the latest edition of this technical data page.

1. GENERAL DESCRIPTION

Foam Makers are in-line fixed foam aspirating devices. They are used in low expansion foam discharge applications to protect tank farm dikes and other low-level discharge applications.

Foam Makers are used in the dike foam delivery system as referred to in design standards such as NFPA 11. The foam makers are part of a low-level foam delivery system that also incorporates foam storage bladder tanks, proportioning devices and suitable foam concentrates.

Foam solution can also be supplied by foam pumping systems or in semi-fixed systems supplied from a portable supply such as a fire brigade appliance.

2. LISTINGS AND APPROVALS

The Foam Maker is FM Approved and UL Listed as part of a fire extinguishing system combining designated foam concentrates, proportioning devices and bladder tanks. Approved and Listed system components can be found at www.approvalguide.com and <https://iq.ulprospector.com>

NOTE: *The information in this document is subject to change without notice.*



FM Approved - Low Expansion Foam Systems (FM5130)



UL Listed – GFUT.EX5194

“SFFF compatible” refers to this product as being part of a SFFF Foam system that has been tested to recognized standards. Not all configurations are available. Please consult technical data and/or the Approval/Listing for usage requirements.

NOTE: Other International approval certificates may be available upon request.

3. TECHNICAL DATA

3.1 Construction Features

- Available in 1.5”, 2.5”, 3”, 4” sizes
- Painted Carbon Steel or Painted Stainless Steel for corrosion protection
- Available with ANSI 150 or PN16 Flanges
- Available with Foam Pourer
- Vertical or Horizontal Installation
- Specifically FM Approved and UL Listed with Viking Foam Concentrates.



WARNING: Cancer and Reproductive Harm-
www.P65Warnings.ca.gov





TECHNICAL DATA

MODEL VFM FOAM MAKERS

The Viking Corporation, 210 N Industrial Park Drive, Hastings MI 49058
 Telephone: 269-945-9501 Technical Services: 877-384-5464 Fax: 269-818-1680 Email: techsvcs@vikingcorp.com
 Visit the Viking website for the latest edition of this technical data page.

3.2 Standard Materials

Table 3.2.1 - Standard Materials		
	Carbon Steel Version	Stainless Steel Version
Body	Carbon Steel ASME SA-106 Gr.B/EN P265GH	Stainless Steel ASME SA-182 F316 / EN 1.4401 AISI-316
Flanges (ANSI 150 or PN16)	Carbon Steel ASME SA-105 / EN P245GH	Stainless Steel ASME SA-182 F316 / EN 1.4401 AISI-316
Calibrated orifice material	Stainless Steel UNS-S30400	Stainless Steel ASME SA-182 F316 / EN 1.4401 AISI-316
Paint	Epoxy zinc-rich primer with aliphatic polyurethane finish	Epoxy zinc rich primer with aliphatic polyurethane finish
Standard color	RAL3000 Red	RAL3000 Red
Inlet Flange Gasket	Composite	Composite

3.3 Standard Design Specifications

Table 3.3.1 - Standard Design Specifications												
Model	Inlet Size	Working Pressure ¹				Flow Range				Orifice Range		Approval ^{2,3}
		Minimum		Maximum		Minimum		Maximum		Inches	mm	
		PSI	bar	PSI	bar	GPM	LPM	GPM	LPM			
VFM	1.5"	30	2.07	125	8.62	6	24	83	313	0.250 – 0.635	6.4 – 16.1	FM/UL
	2.5"	30	2.07	125	8.62	26	98	226	855	0.510 – 1.050	13.0 – 26.7	FM/UL
	3"	30	2.07	125	8.62	82	312	480	1818	0.906 – 1.531	23.0 – 33.9	FM/UL
	4"	30	2.07	125	8.62	131	496	740	2800	1.142 – 1.900	29.0 – 48.3	FM/UL

Footnotes:
¹ Working pressure at the inlet orifice of the foam maker.
² Please refer to www.approvalguide.com for specific approval data. Note that approved Working Pressures and Flow Ranges are specific to the tested foam concentrate.
³ Please refer to <https://iq.ulprospector.com> for specific listing data. Note that listed Working Pressures and Flow Ranges are specific to the tested foam concentrate.

3.3.1 Determining Orifice Size

After determining the required foam flow rate and available pressure, the orifice must be sized using the following formula:

$$d = \left(\frac{Q}{18.327 \cdot P^{1/2}} \right)^{1/2}$$

d = Orifice Ø (in.)
 Q = Solution Flow Rate (GPM)
 P = Pressure at orifice inlet (PSI)



TECHNICAL DATA

MODEL VFM FOAM MAKERS

The Viking Corporation, 210 N Industrial Park Drive, Hastings MI 49058
 Telephone: 269-945-9501 Technical Services: 877-384-5464 Fax: 269-818-1680 Email: techsvcs@vikingcorp.com
 Visit the Viking website for the latest edition of this technical data page.

3.4 Ordering Information

The inlet orifice plate(s) are manufactured according to your specific project requirements. The following steps should be followed to ensure the correct order processing information is specified.

1. Use the tables in section 7 (Performance Data) to determine what size Foam Maker will satisfy the flow and pressure requirements for your specific project. (Required)
2. Select the Foam Maker size, flange pattern and material from table 3.4.1. (Required)

NOTE: The Foam Maker part number from this table is used at the quotation stage only for the Americas ordering territory.

3. Select a Foam Pourer, if used, with the flange pattern that matches the outlet flange pattern of the Foam Maker. (Required)
4. When the official purchase order is made for a Foam Maker, the size, orifice inlet pressure, and desired flow rate must be provided. Please use the Foam Maker order form (F_061317A) to ensure your order is processed correctly (Required)

NOTE: The inlet orifice size will be manufactured to match the pressure and flow information that you provide in step 5.

The final (ordering) part number for the Americas ordering territory will be the base part number for the Foam Maker and a serialized suffix.

Refer to your customer service representative for further information and order form.

Table 3.4.1 Ordering Information

Description	Material	Finish	Part Number		Weight	
			ANSI	PN16	Lbs.	Kg
1.5" Foam Maker	Carbon Steel	Painted	F21216	F21217	17.2	7.8
Foam Pourer for 1.5"	Carbon Steel	Painted	F21255	F21256	18.0	8.3
1.5" Foam Maker	Stainless Steel	Painted	F21218	F21219	18.1	8.2
Foam Pourer for 1.5"	Stainless Steel	Painted	F21257	F21258	19.0	8.8
2.5" Foam Maker	Carbon Steel	Painted	F21221	F21222	25.6	11.6
Foam Pourer for 2.5"	Carbon Steel	Painted	F21255	F21256	18.0	8.3
2.5" Foam Maker	Stainless Steel	Painted	F21223	F21224	26.9	12.2
Foam Pourer for 2.5"	Stainless Steel	Painted	F21257	F21258	19.0	8.8
3" Foam Maker	Carbon Steel	Painted	F21226	F21227	43.0	19.5
Foam Pourer for 3"	Carbon Steel	Painted	F21259	F21260	23.0	10.4
3" Foam Maker	Stainless Steel	Painted	F21228	F21229	45.2	20.5
Foam Pourer for 3"	Stainless Steel	Painted	F21261	F21262	24.0	11.1
4" Foam Maker	Carbon Steel	Painted	F21231	F21232	68.6	31.1
Foam Pourer for 4"	Carbon Steel	Painted	F21263	F21264	41.0	18.5
4" Foam Maker	Stainless Steel	Painted	F21233	F21234	72.1	32.7
Foam Pourer for 4"	Stainless Steel	Painted	F21265	F21266	43.0	19.6



TECHNICAL DATA

MODEL VFM FOAM MAKERS

The Viking Corporation, 210 N Industrial Park Drive, Hastings MI 49058

Telephone: 269-945-9501 Technical Services: 877-384-5464 Fax: 269-818-1680 Email: techsvcs@vikingcorp.com

Visit the Viking website for the latest edition of this technical data page.

4. SCOPE OF DELIVERY

Ensure that all components are complete and in good condition.

Included

- Foam Maker
- Sized Orifice (Quantity x 1)
- Inlet Flange Gaskets (Quantity x 2)

Not Included

- Foam Pourer (Sold Separately - see Table 3.4.1)
- Nuts, Bolts, Washers
- System pipework and fittings.

5. AVAILABILITY

Please contact your local Viking sales office for further information. The product is available directly from Viking and official distributors only.

Americas:

The Viking Corporation
5150 Beltway SE
Caledonia, MI 49316
Tel.: (800) 968-9501
Fax: 269-818-1680
Technical Services: 1-877-384-5464
techsvcs@vikingcorp.com

EMEA:

Viking S.A.
21, Z.I, Haneboesch
L-4562 Differdange / Niederkorn
Tel.: +352 58 37 37 – 1
Fax: +352 58 37 36
vikinglux@viking-emea.com

Asia Pacific (APAC) Main Office:

The Viking Corporation (Far East) Pte. Ltd.
69 Tuas View Square
Westlink Techpark, Singapore 637621
Tel: (+65) 6 278 4061
Fax: (+65) 6 278 4609
vikingAPAC@vikingcorp.com

6. PRODUCT VARIANTS

6.1 Options

- Also available with Galvanized or Paint over Galvanized Finish (Not FM Approved or UL Listed)
- Various colors



TECHNICAL DATA

MODEL VFM FOAM MAKERS

The Viking Corporation, 210 N Industrial Park Drive, Hastings MI 49058
 Telephone: 269-945-9501 Technical Services: 877-384-5464 Fax: 269-818-1680 Email: techsvcs@vikingcorp.com
 Visit the Viking website for the latest edition of this technical data page.

6.2 Dimensions: Foam Makers

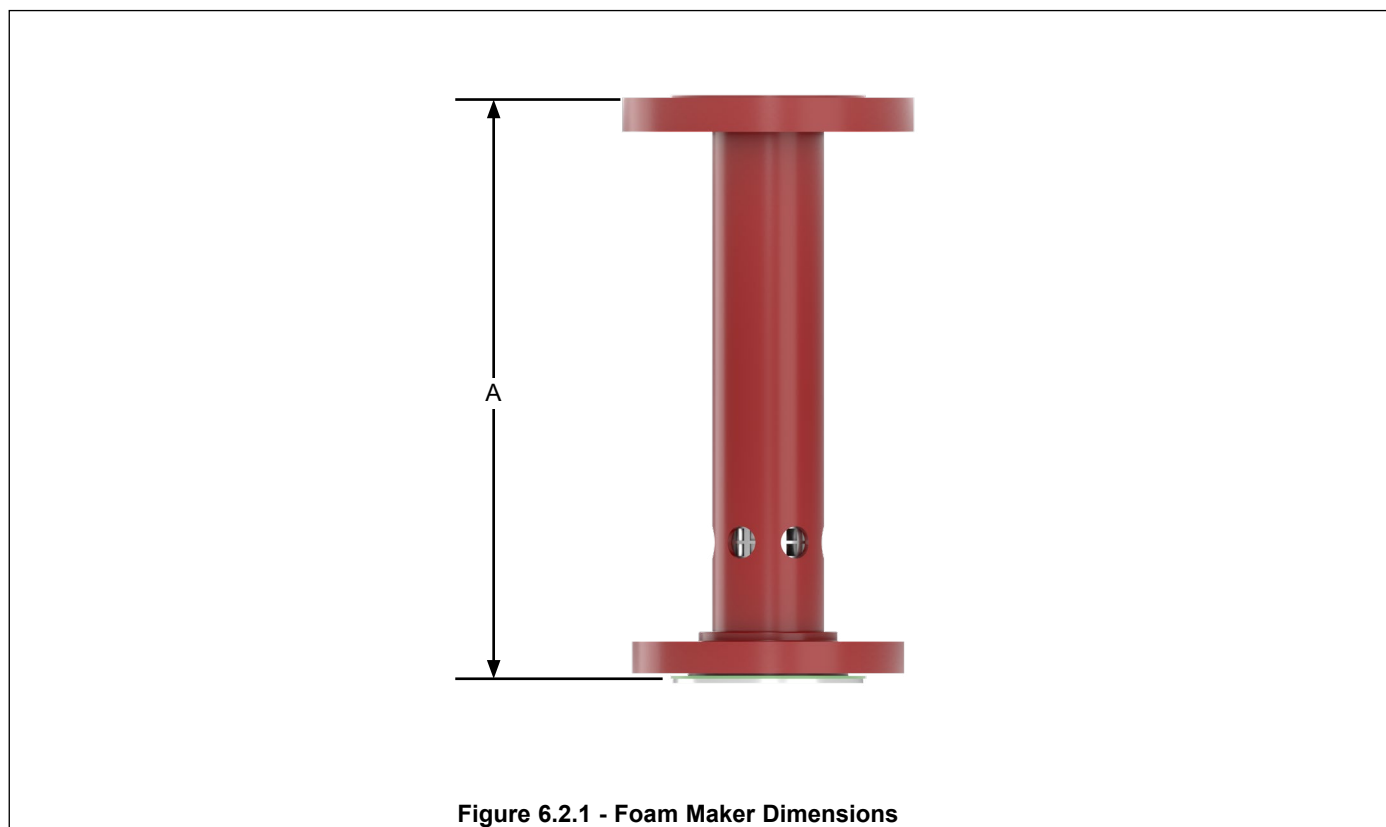

Figure 6.2.1 - Foam Maker Dimensions

Table 6.2.1 - Foam Maker Dimensions

Part Number	Foam Maker / Inlet Flange Size	Outlet Flange Size	Material	Flange	A	
					Inches	mm
F21216	1-1/2"	3"	Steel	ANSI	13.68	322
F21217			Steel	PN16		
F21218			Stainless Steel	ANSI		
F21219			Stainless Steel	PN16		
F21221	2-1/2"	3"	Steel	ANSI	14.92	379
F21222			Steel	PN16		
F21223			Stainless Steel	ANSI		
F21224			Stainless Steel	PN16		
F21226	3"	4"	Steel	ANSI	30.00	762
F21227			Steel	PN16		
F21228			Stainless Steel	ANSI		
F21229			Stainless Steel	PN16		
F21231	4"	6"	Steel	ANSI	35.98	914
F21232			Steel	PN16		
F21233			Stainless Steel	ANSI		
F21234			Stainless Steel	PN16		



TECHNICAL DATA

MODEL VFM FOAM MAKERS

The Viking Corporation, 210 N Industrial Park Drive, Hastings MI 49058

Telephone: 269-945-9501 Technical Services: 877-384-5464 Fax: 269-818-1680 Email: techsvcs@vikingcorp.com

Visit the Viking website for the latest edition of this technical data page.

6.3 Dimensions: Foam Pourers

The Foam Pourer is used to discharge expanded foam back against the dike wall to ensure a uniform and gentle application on the dike floor / fuel surface.

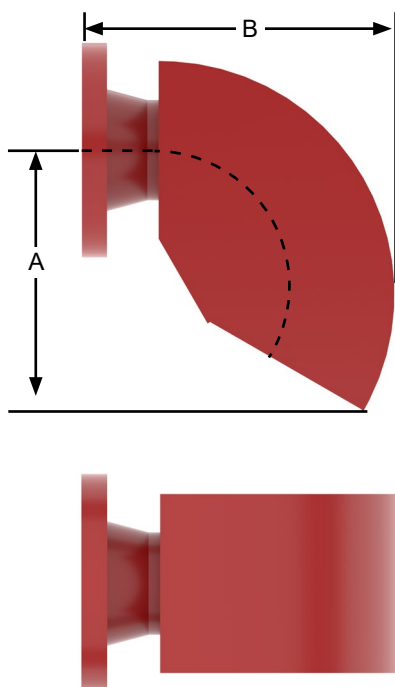

Figure 6.3.1 - Foam Pourer Dimensions

Table 6.3.1 - Foam Pourer Dimensions

Part Number	Foam Maker Size	Foam Pourer/ Flange Size	Material	Flange	A		B	
					Inches	mm	Inches	mm
F21255	1-1/2" and 2-1/2"	3"	Steel	ANSI	9.09	231	11.02	280
F21256			Steel	PN16			10.24	260
F21257			Stainless Steel	ANSI			11.02	280
F21258			Stainless Steel	PN16			10.24	260
F21259	3"	4"	Steel	ANSI	9.09	231	11.26	286
F21260			Steel	PN16			10.31	262
F21261			Stainless Steel	ANSI			11.26	286
F21262			Stainless Steel	PN16			10.31	262
F21263	4"	6"	Steel	ANSI	12.52	318	15.12	384
F21264			Steel	PN16			13.78	350
F21265			Stainless Steel	ANSI			15.12	384
F21266			Stainless Steel	PN16			13.78	350



TECHNICAL DATA

MODEL VFM FOAM MAKERS

The Viking Corporation, 210 N Industrial Park Drive, Hastings MI 49058
 Telephone: 269-945-9501 Technical Services: 877-384-5464 Fax: 269-818-1680 Email: techsvcs@vikingcorp.com
 Visit the Viking website for the latest edition of this technical data page.

7. PERFORMANCE DATA

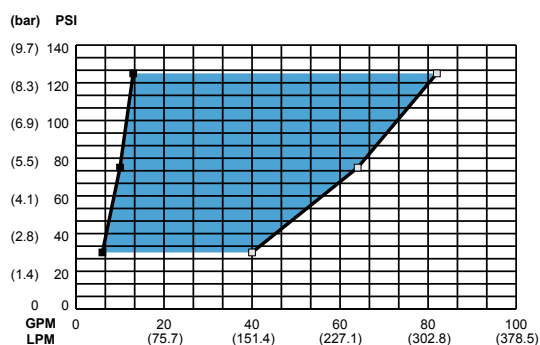

MINIMUM FLOW: 6 GPM (24 LPM)
 MAXIMUM FLOW: 83 GPM (313 LPM)
1.5" FOAM MAKER

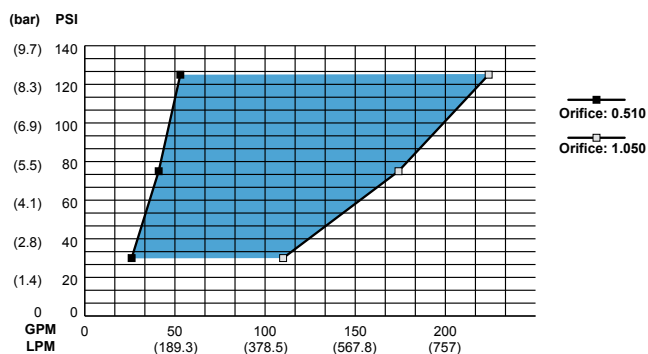

MINIMUM FLOW: 26 GPM (98 LPM)
 MAXIMUM FLOW: 224 GPM (848 LPM)
2.5" FOAM MAKER

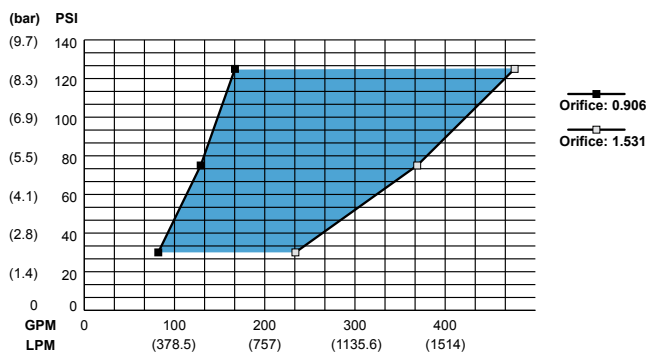

MINIMUM FLOW: 82 GPM (312 LPM)
 MAXIMUM FLOW: 480 GPM (1818 LPM)
3" FOAM MAKER

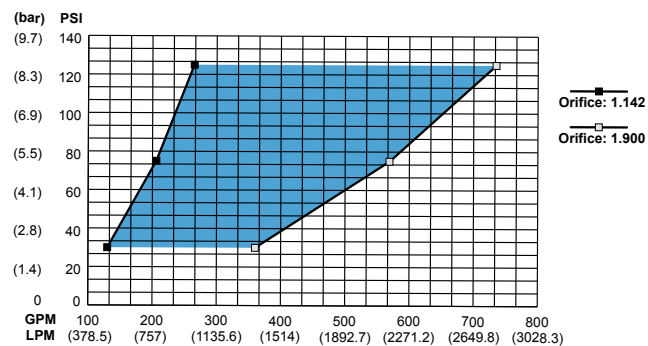

MINIMUM FLOW: 131 GPM (496 LPM)
 MAXIMUM FLOW: 740 GPM (2800 LPM)
4" FOAM MAKER

Graph 7.1.1 - Performance Data



TECHNICAL DATA

MODEL VFM FOAM MAKERS

The Viking Corporation, 210 N Industrial Park Drive, Hastings MI 49058

Telephone: 269-945-9501 Technical Services: 877-384-5464 Fax: 269-818-1680 Email: techsvcs@vikingcorp.com

Visit the Viking website for the latest edition of this technical data page.

8. INSTALLATION

The foam/water solution supply provided to the foam makers must be continuous, clean, and obstruction free. Foam makers should be installed with adequate clearance and be protected from physical damage. Adequate clearance should be maintained for maintenance and inspection.

Foam makers are deluge system discharge devices, and should be provided with adequate shutoff capabilities during adjustment or maintenance. The foam maker should be installed in accordance with NFPA 11: The Standard for Low-Expansion Foam or other applicable standards.

The foam maker inlet is to be mounted to a compatible piping flange. Piping to the foam maker should be self-supporting and installed in accordance with NFPA 11 or other applicable standards.

The foam maker orifice plate is to be installed between the inlet flange and the supply piping flange.

Orifice plate gaskets are to be installed against the inlet flange and the supply piping flange.

The orifice plate has a knife-edged or tapered-edge orifice. The flat side of the orifice plate is to be installed facing the supply piping flange. Orifice plates are identified according to size by numeric values indicated on the orifice plate. Prior to installation of an orifice plate, verify the suitability of the orifice plate for the specific range of flows and pressures required for the foam maker.

Discharge piping is to be sized in accordance with the outlet sizing charts for the specific foam maker. (Table 6.2.1)

Normal methods of piping the discharge outlet from the foam maker is to install the foam maker horizontal and rise up from the end of the foam maker with a 90 degree elbow, cross over the dike wall, drop down the dike wall and terminate with the foam pourer directed back towards the wall. See Figure 8.1.1 - Typical Installation.

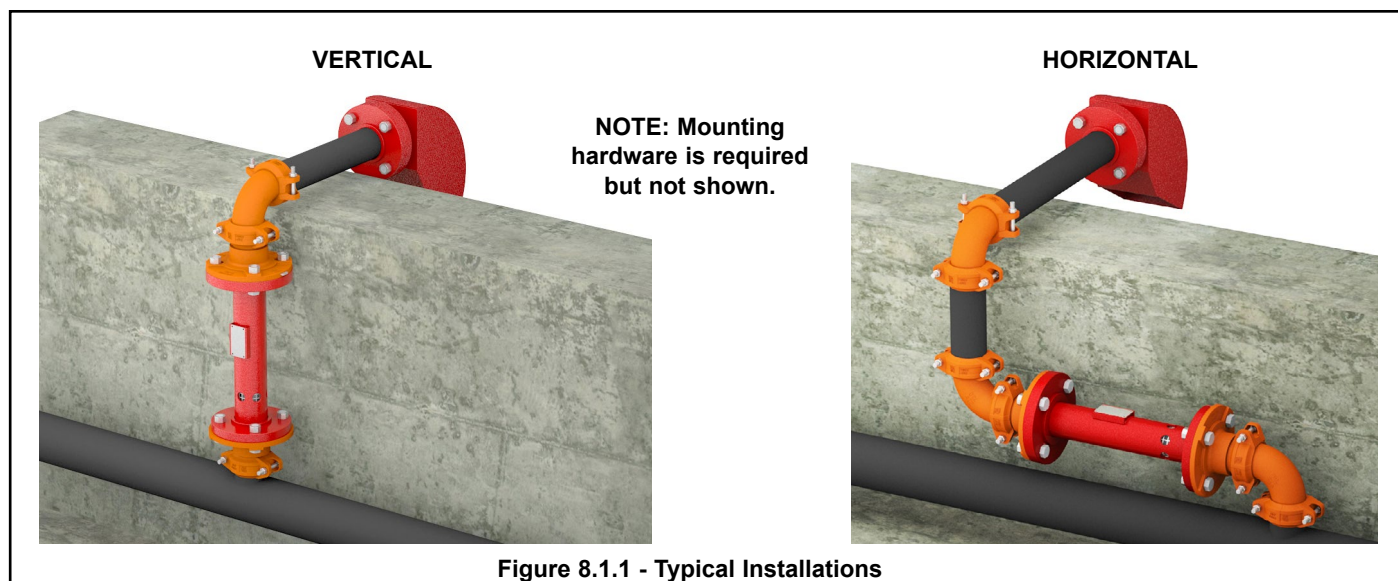

9. OPERATION

The Foam Maker is an in-line foam discharge device. Foam/water solution is provided in a “pre-mix” condition through either an automatic or mobile proportioning system. The foam maker does not proportion foam concentrate into the water stream.

Foam/water solution is supplied to the inlet side of the foam maker. The inlet side of the foam maker is equipped with an orifice plate and air strainer. When foam solution initially passes through the air strainer, water will discharge from the vent holes. When the flow rate is of a greater velocity, a venturi effect will draw air into the fluid stream at a greater rate than water is escaping. At this point, solution will cease to flow from the air strainer.

The foam solution is aerated, which will cause the foam discharge to expand. The aerated foam solution will have enhanced foam qualities of greater expansion and normally longer drain times. The foam maker used with the foam pourer has an increased outlet size to allow for the foam expansion. The foam pourer then discharges foam indirectly at a burning liquid by deflecting the foam at the interior wall of a dike or bund area. Foam then spreads across the surface of the dike or bund area and covers the burning liquid, creating a vapor barrier to suppress or extinguish the fire.



TECHNICAL DATA

MODEL VFM FOAM MAKERS

The Viking Corporation, 210 N Industrial Park Drive, Hastings MI 49058
 Telephone: 269-945-9501 Technical Services: 877-384-5464 Fax: 269-818-1680 Email: techsvcs@vikingcorp.com
 Visit the Viking website for the latest edition of this technical data page.

10. GUARANTEE

For details of warranty, refer to Viking's current list price schedule or contact Viking directly.

11. INSPECTIONS, TESTS, AND MAINTENANCE

NOTICE

The owner is responsible for maintaining the fire protection system and devices in proper operating condition.

⚠ WARNING

Any system maintenance that involves placing a control valve or detection system out of service may eliminate the fire protection capabilities of that system. Prior to proceeding, notify all Authorities Having Jurisdiction. Consideration should be given to employment of a fire patrol in the affected areas.

It is important that the system is inspected and tested on a regular basis. This is the owner's responsibility. System piping is to be hydrostatically tested as prescribed in NFPA 11: The Standard for Low-Expansion Foam. Foam maker supply piping is to be flushed after use in accordance with NFPA 11.

The air screen is to be inspected for obstruction of air inlet holes. If any obstruction exists, remove the obstruction and flush as necessary. The air strainer is over sized to prevent obstruction from nesting.

12. DISPOSAL



At end of use the product described here should be disposed of via the national recycling system. Upon request, the manufacturer can take back and properly dispose of the electrical equipment and electronic devices.

13. ACCESSORIES AND SPARE PARTS

- When the official purchase order is made for the orifice plate, the foam maker size, the orifice inlet pressure and desired flow rate must be provided (required).

NOTE: The inlet orifice size will be manufactured to match the pressure and flow information provided in step 1. Any modifications made after the release of the foam maker are the responsibility and at the risk of the authorized purchaser. Changes could include but are not limited to an entire system redesign, revamping of system components, restocking fees, etc.

- The final part number will include the base part number followed by a custom serialized number.

Table 13.1.1 - Accessories		
Orifice Plates		
Part Number	Orifice Size Range	Foam Maker Size
F21430	0.250" - 0.635"	1-1/2"
F20911	0.510" - 1.050"	2-1/2"
F20936	0.906" - 1.531"	3"
F20948	1.142" - 1.900"	4"

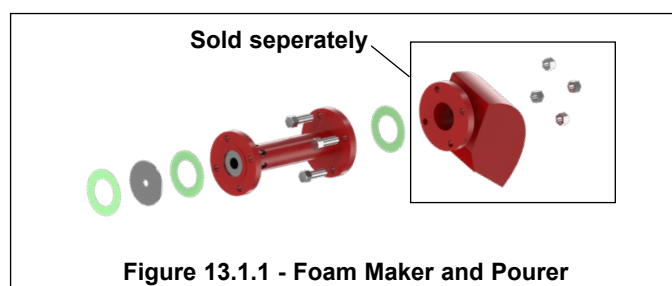

14. DECLARATION OF CONFORMITY

If required, contact the appropriate sales office in **Section 5 Availability** for further assistance.